

Review

Hot Isostatic Pressing (HIP) technology and its applications to metals and ceramics

M. H. BOCANEGRA-BERNAL

Centro de Investigación en Materiales Avanzados, CIMAV S.C., División de Materiales Cerámicos y Beneficio de Minerales, Miguel de Cervantes # 120 Complejo Industrial Chihuahua, 31109 Chihuahua, Chihuahua, México
E-mail: miguel.bocanegra@cimav.edu.mx

This review examines some of the components of this increasingly exploited technology as well as the application of which will surely increase as a result of constant development in equipment design and extensive research in the field of ceramic and metal materials in general for the production of fully dense and reliable parts. Newly developed high temperature HIP equipment can offer potential improvements to material properties relative to more conventional techniques as a possible solution to the manufacture of ceramic and metal components for airframe and structural components where critical and highly stressed applications are required. By the use of the near net shape techniques, exotic materials can be used more cost effectively than machining from solid. Designers and manufacturers alike can make better products by introducing HIP to their production route.

© 2004 Kluwer Academic Publishers

1. Introduction

Hot Isostatic Pressing (HIP) techniques play an important role in the research and development of different materials, including metals and ceramics. In the HIP technology, high temperature and high gas pressure can be simultaneously applied to workpieces resulting in fully isotropic material properties [1–3]. It thus offers unique benefits for metal, ceramic and refractory applications. The ability to form product shapes to precise tolerances (reducing costly machining) has been a major driving force for its commercial development [4]. HIP can be used directly to consolidate a powder or supplementary to further densify a cold pressed, sintered, or cast part. The HIP process, which subjects a component to elevated temperatures (generally over 1000°C) and pressures (generally over 98 MPa (1000 kgf·cm⁻²)) to eliminate internal microshrinkage, helped engineers respond to the aerospace industry's increasingly stringent regulations. HIP enabled engineers to design components so they could meet specifications for use in critical, highly stressed applications [5–8]. HIP is also used to optimise the properties of the latest generations of single crystal and directionally solidified investment cast blades. For parts that are subjected to such high in-service stresses, the removal of porosity is essential to maximise the properties and working life of the component. HIP can also be used to rejuvenate turbine blades by removing creep porosity developed during service.

Since Hot Isostatic Pressing was invented in the United States (Battelle Institute) [8, 9] as a technique

for a diffusing bonding of nuclear fuel element assemblies. It can bond materials, which are difficult to bond only at a high temperature, using a multiplier effect of high temperature and isostatic pressure. Initially at the Institute, as it was used for the bonding of similar or different materials, it was called Gas Pressure Bonding [7]. Pore free sintered parts such as hard metal tools, high speed steel billets, P/M superalloys and soft ferrites for magnetic recording heads are some of the products produced via the HIP process. However, the range of applications for hot isostatic pressing is expanding rapidly, from producing dense components from powdered metals and ceramics [5].

Another fundamental application of the HIP process is cladding. Cladding is the selective bonding of hardfacing materials onto various substrate surfaces. A less expensive material is coated with a thin layer of powdered metal, creating a buffer on its wear surface. This reduces costs by placing expensive, wear resistant materials only where they are needed. As a result, wear resistant properties are improved without incurring unnecessary cost penalties. An additional benefit of cladding is that it can create bonds between otherwise incompatible materials such as metal, intermetallic, and ceramic powders. For most applications a small amount of residual porosity is not detrimental to product performance. However, for high performance applications, the product can be Hipped or Sinter-Hipped [10].

To densify a powder directly requires a can to transmit the pressure to the powder. This can (mold) can be mild steel, stainless, an exotic metal, or a glass capsule.

This method is used when a simple shape is required. When a complex shape (such as a turbocharger blade) is required, it is common to cold press first because a rubber mold is much easier to make than a stainless steel mold. The cold pressed part (called as green body) can then be sintered to a high enough density to close any interconnecting porosity. This part can then be hot isostatically pressed without a can (mold) as the part itself will transmit the force to any internal porosity [6].

The HIP process enables engineers to produce materials of all shapes and sizes, including cylindrical billets, flat rectangular bar billets, solid shapes with complex external geometry, and complex shapes with internal cavities. Because powder metals do not have the directional property characteristics of forgings, the HIP process can produce materials from metallic compositions that are difficult or impossible to forge or cast [5].

A technological problem exists in the HIP equipment itself. For example, some ceramics, such as Si_2N_4 and SiC must be HIPed at temperatures so high above 1600°C , that special HIP equipment stable at such as high temperatures must be developed. Another problem is economy. So, according to the amount and the type of the product, a proper selection of HIP equipment must be made.

For instance, high performance ceramics, especially high temperature ceramics such as silicon nitride and silicon carbide, were the first of these materials to be produced commercially, and HIP has been considered one the most promising technologies to manufacture parts with sufficient mechanical strength and reliability made from these materials [1, 11–14]. From the viewpoint of HIP equipment, precise temperature control at temperatures higher than 1600°C and more, economical operation is desired.

Oxide ceramics have a long history of development and therefore are the most familiar to us of the many existing ceramic materials. Their manufacturing process, however, is still being improved in order to meet new requirements in properties and reduced processing costs. About fifteen years ago, the HIP was introduced to manufacture alumina cutting tool inserts with excellent cutting properties at a reasonable cost. Since that, the application of HIP to oxide ceramics [15–18] has eventually spread to other oxide such as Mn-Zn ferrite, PZT and PSZ. In these cases, HIP has been performed using a completely inert argon gas as a pressure medium gas.

Rapid advances in industrial equipment require stronger and tougher materials. In heat engines, research and development are focussed on a higher operation temperature to enhance their energy efficiency. In order to meet this requirement, many metallurgists have been searching for new superalloys which can stand higher temperatures, while ceramists have been challenging to replace some engine parts with non-oxide ceramics. HIP has been used as a means to fully densify the powder materials and is now deemed to be the most promising technique in terms of its shape making possibility. HIP is a process in which sintered parts containing residual closed porosity or encapsulated powder bodies are subjected to a high gas pressure at an elevated temperature. In order to utilize HIP in the production of

ceramic engine parts, however, some impediments must be removed. These ceramics, mainly nitrides and carbides, must be processed at temperatures over 1600°C , but conventional HIP equipment was no able to work stably at such high temperature. Now, however, HIP equipment technology is also changing and several approaches employing new high temperature HIP equipment are being studied. This rapidly advancing technology offers many possibilities. New applications are constantly being discovered. In the last decade it has become a reliable process for commercial applications. The furnaces are of various types, to particular requirements, such as: (i) Oxygen resistant kanthal heating elements for temperatures up to 1200°C : These allow hot loading and unloading of the workpieces, (ii) Molybdenum heating elements for temperatures up to 1450°C : used mainly for densification of materials sensitive to surface contamination and (iii) Graphite heating elements for temperatures of 2000°C or above: permit treatment of materials in either an argon or nitrogen atmosphere [4, 19, 20].

On the most important problems to commercialize ceramics such as non-oxide ceramics (silicon nitride and silicon carbide) is the R & D to produce high strength parts with complex shape. However, recent development within the hybrid electric car gas turbine project has resulted in improved high temperature material properties, and components like combustion parts and turbine wheels have been fabricated to near-net-shape with these materials. For such components, a highly uniform green powder body is desired and combined with a type of encapsulation or container during HIP which does not create shear stresses at the surface if the green body during shrinkage/sintering to full density but prevents penetration into the body, optimal near-net-shape results can be achieved [21]. However, the containers such as glass were used for HIPing and there have been still some problems on practical use, i.e., the production of complex shaped container, the prevention of reaction between silicon nitride and container and so forth. On the other hand, HIP method which needs no container (containerless HIPing) has been applied to cemented carbides, alumina, ferrites, porous ceria doped tetragonal zirconia and piezoelectric ceramics [22, 23].

HIP technology applications have expanded to the manufacture of high speed tool steel and Co based alloys. Focussing on the past several years, extensive research and development of HIP process technology has been carried out for oxides (O_2 – HIPing), nitrides, carbides, metals and fiber-reinforced metals [24, 25]. In actual production, high strength partially-stabilized-zirconia parts [23, 26, 27], diffusion bonded mechanical parts as cemented carbide composites [28] and complex engine casings over one metre in diameter, for example, are new products manufactured by the HIP process. This technique is applied to post-densify performed and sintered parts and castings, or to densify powders at near net shape or to billets [29, 30].

The advantages offered by HIPing are well known. It provides: uniform density very close to theoretical density, elimination of porosity, improved fatigue

properties, improve creep properties, improved ductility and impact strength, decreased scatter of properties, fine grain size structure, the ability to densify powder which are otherwise difficult to compact, the possibility of making composite parts, recovery of defective parts, materials savings by using the Hot Isostatic Pressing net shape approach [31]. HIP is drawing increasing interest because relative high pressure, up to 200 MPa, is easily facilitated and currently used for the production of ceramics [4, 5, 30, 32].

The most of the installations were for research and development of advanced materials, particularly high performance ceramics such as PSZ, Si_3N_4 and SiC. In fact, various kinds of high strength PSZ parts are now being produced by using these units [1, 22, 23]. The number and potential applications of Hot Isostatic Pressing have increased and a HIP unit can now be considered a generally accepted item of equipment in modern industry. Compacting at an elevated temperature serves first, to eliminate the effects of work—hardening; secondly, to reduce the stress of which plastic deformation occurs: and thirdly, to allow densification to continue during the time for which the temperature and pressure are maintained. It has been found that the HIP can achieve a surprising degree of shape control and accuracy [30, 31, 33].

2. High—temperature HIP equipment

In order to produce high-temperature ceramics such as silicon nitride or silicon carbide, precise temperature control above 1600°C is necessary. HIP equipment is basically an electric furnace which is contained in a pressure vessel. Its design concept, however, is considerably different from that of ordinary electric furnaces under atmospheric pressure or in vacuum. This difference is mainly attributable to the nature of the high-pressure transmitting gas with which the pressure vessel is filled: the viscosity of the gas, usually in an inert gas such as argon, is very low, while its density is very high, so that the heat generated by the heating is transferred mainly by the natural convection of the gas. The furnace structure, including the heating device and heat insulation, is usually made of heat-resistant alloys or refractory metals [34, 35].

The growing demand for the production of fully dense and high strength ceramic parts has lead ceramic engineers to search for new technologies, and recently, some results of HIP densification of sintered silicon nitride using these furnaces have proven that these ceramics can be fully densified with remarkable enhancement in strength. Undoubtedly, the principal features of the furnace structure are: (i) independent graphite or molybdenum heaters (although other materials such as tungsten, platinum, Ni-Cr alloys or kanthal are available for certain applications), which have no ceramic electric insulation in their hot zone, and (ii) thermal insulation formed of several different kinds of carbon materials [9, 35]. Molybdenum and graphite constructions have limited life in oxidizing atmospheres and rely on the non-reactivity of the pressuring gas for their continued functioning. The most important elements of the HIP equipment are summarized as follows:

2.1. Pressure vessel

The pressure vessel [35] is one of the major components of this equipment. Owing to the enormous accumulated energy and the cyclic character of the operation, the main concern is safety. To achieve an acceptable safety level, the optimum combination of many factors is required, namely the knowledge and control of all stress factors (finite analysis, stress concentration, stress corrosion and so forth). Therefore, the vessel, should also be constructed such that it is immune to, or protected against, the influence of the cooling fluid and/or the failure of the cooling system that evacuates the heat losses through the heat barrier during the heating, dwell and cooling periods. The thermal conductivity, as well as the heat capacity, should be sufficiently high to avoid a considerable temperature increase in the steel.

2.2. Furnace

The furnace consists of a heater which produces high temperature, a thermal barrier which maintains the inside of the furnace at a high temperature and protects the pressure vessel from internal high temperature, and a temperature monitoring system. Fig. 1 shows the basic concept of a furnace.

The furnace must produce the power to heat up the workload to the desired temperature at the desired rate and with the required accuracy. All HIP furnaces, make use of some combination of the three types of heat transfer: conduction, convection and radiation. Since the thermal conductivity of argon, the most frequently used gas, is low, conduction contributes only a small percentage of the total heat transfer [36]. The inert gas argon and helium have both been used for transmitting pressure. Helium, which appears to have been used

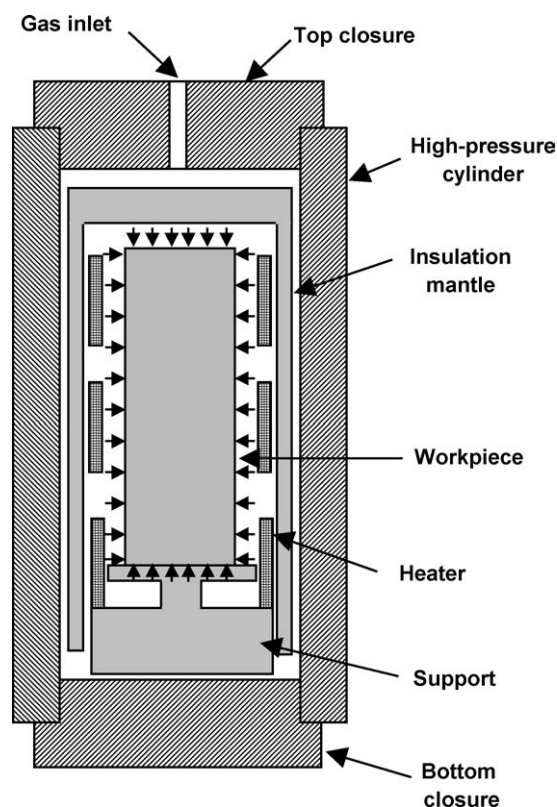

Figure 1 Schematic drawing of HIP unit [From ref. 7].

almost exclusively in the extensive work at the Battelle Memorial Institute [33], has certain advantages over argon. Its greater thermal conductivity leads to more uniform temperatures within the work space together with better temperature control. Also the higher density of argon results in a greater heat transfer by gas convection which may cause uneven hot—zone temperatures and irregular heat flow through the insulation.

Since the HIP furnace structure dominates the equipment performance [9, 35], the furnace structure and the materials used should be quite different from conventional HIP furnaces. Refractory metals such as Mo, W and Ta which are used in the conventional HIP furnaces, often cause creep deformation under high temperatures. They also become fragile after the first several runs of the HIP cycle and might cause a significant failure due to a slight shock as the workload is handled during the HIP process. By taking these points into account, carbon is so far the best choice for constructing HIP furnaces structures.

However, it is very important taking into account the influence of the heater material (Mo or C mainly) on the mechanical properties of presintered ceramics, for example, containing >98% Al_2O_3 , since it is well known that the optimum HIP temperature for ceramics with a high glass-phase is about 1200°C. At higher HIP temperatures, argon from the environmental atmosphere can penetrate into the pores of the material, worsening its properties.

On the other hand, for materials with higher Al_2O_3 content (up to 99%), the HIP temperature must be raised. A carbon-containing atmosphere in the high-pressure vessel adversely affects the mechanical properties of the material. For this, it is desirable to conduct the HIP process in furnaces with Mo heaters [20], inasmuch as the optimum HIP parameters depend on the composition and previous technological history of the ceramic materials.

2.3. Heating elements

The materials used for the construction of the heating elements fall into two categories: those which support an oxidizing atmosphere at temperature and those which need protection from an inert atmosphere above a certain temperature. The first category (i.e., Nichrome and Kanthal) enable hot unloading and loading of the HIP, resulting in a considerable reduction in cycle time. However, their use is limited to temperatures up to about 1200°C. The second category enable operations at considerably higher temperatures. However, since they become oxidized at elevated temperatures, they have to be used in so called cold loading presses [36]. Molybdenum fall into this category and is widely used because it is available in different forms (wire, strips and sheets) and is easily deformable, thus facilitating the construction of the furnace element; in addition, a molybdenum element is easily repaired and allows a clean operational environment. Molybdenum windings are suitable for the temperature range 1000–1650°C, within which most Hot Isostatic Pressing is carried out. For temperatures above the range of molybdenum, graphite is used, but this demands low—voltage high current power sup-

plies and inconveniently large conductors have to be taken through the pressure vessel wall. Therefore, the development of an interlocking tungsten—mesh heater, which is claim to be non—sagging after use 2800°C, may be an acceptable alternative to graphite for very high temperature operation [35, 37].

Rapid failure of the heating element is likely and, in extreme cases, damage to the pressure vessel seals. The problem is largely overcome by using the highest possible insulation density [33]. Thermal insulation plays a great role in the HIP furnace especially with high temperature HIP equipment, because the insulation affects the heating and cooling rate which in turn has a close connection with processing cost. In order to achieve a reasonable heat insulating performance with also reasonable thickness of thermal insulation, a combination of carbon materials, such as graphite, flexible graphite sheets and carbon fiber have been used [9]. The insulation has to meet a number of requirements, the most important of which are that it should: (i) provide good insulation with the purpose to reduce power consumption and to keep the vessel wall at fairly low temperatures, (ii) allow sufficient heat loss in order to no lengthen considerably the cooling period, (iii) prevent loops which would make the insulation inefficient and also would prevent the stabilizing of uniform temperatures, (iv) withstand a considerable temperature gradient, which produces important differences in thermal expansion, and (v) be slender, because it determines the size of the vessel [36]. It is important to point out that the optimum insulation design has to be a compromise between such requirements.

2.4. Pressure system

Originally, helium was used as a pressure medium. Its density was much lower than that of argon and it has a much better conductivity. Nonetheless, argon is now the gas predominantly used as the pressure medium, mainly for reasons of cost.

Likewise, as mentioned above, it is important to take into account the viscosity of the gas. For example, at 1000°C with 98 MPa of argon, the gas has approximately 30% density and 15% coefficient of viscosity of water, and its large coefficient of thermal expansion easily produces intensive convection. The convection makes the HIP device a bigger coefficient of thermal conductivity rather than normal electric furnace [7]. Fig. 2 shows the density and coefficient of viscosity of argon gas under ambient pressure.

The heating of the gas also causes a rise in pressure so that, in principle, the compression system only requires an increase in the gas pressure until some medium pressure is reached. Now, the medium pressure to which the compressor should pump in order to reach maximum pressure with further heating is, however, dependent upon the amount of load in the work zone.

Therefore, it is recommended that the compressor system be capable of pressurizing the gas up to the maximum work pressure [36]. Either multistage or diaphragm compressors can be used to generate the required pressures. The multistage type has been used, combined in parallel for better control of the rate

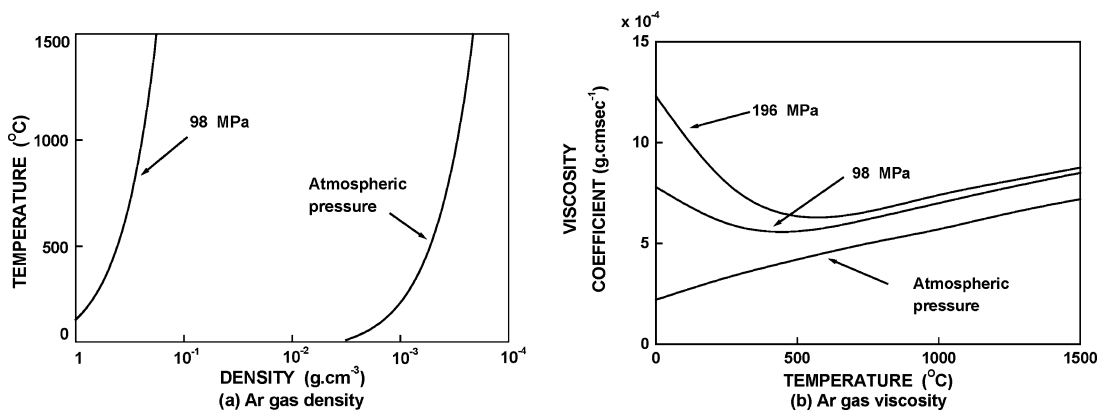

Figure 2 Physical properties of Ar gas at high pressure [From ref. 7].

pressure rise [35, 38]. Diaphragm compressors result in less contamination of the gas, which is of paramount importance when refractory—metal heating elements are used [35, 39], but are less suitable for helium than argon. However, with these high-pressure systems it is essential to incorporate several safety features, such as bursting disc and relief valves.

The hazards gas autoclaves present are such that the equipment is best sited below ground and operated by remote control [37, 39, 40]. This control system should allow automating operation of the total heating, dwell, and cooling cycle with the option of manual override when necessary. The control system must also regulate the pressure and maintain it at the required level during the dwell time. Since the pressure tends to rise during the dwell time, the control system will intermittently expel small amounts of gas from the vessel to keep the pressure within prescribed limits. Both pressure and temperature can be independently and simultaneously programmed using a variety of profile generators, the choice of which will depend upon the complexity of the program selected. The system usually incorporates recorders to register the important process parameters of the cycle. Modern equipment now makes use of microprocessors which provide a wide range of possibilities for the control of the various parameters and for the activation of a complete alarm system.

2.5. Thermocouples

Temperature measurement at high temperature in HIP equipment is usually done by using the commercially available tungsten-rhenium thermocouple. The problem with this, is the readily degradable behavior of such thermocouples above 1800°C. Therefore, improvement of thermocouples and other temperatures measurement device is a key to commercial utilization of high-temperature HIP equipment. Moreover, the thermocouples are, for the present, designed to be easily replaceable by new ones in the form of units consisting of thermocouples wires, a protection tube, insulators and a connector [1, 9].

Usually in the HIP furnace, the heating device is divided into several zones. Therefore, several pairs of thermocouples are employed to control the corresponding zone temperature. Up to approximately 1700°C, a platinum-rhodium thermocouple may be used, how-

ever, above 1700°C the tungsten-rhenium thermocouple is the only one commercially available. But even the tungsten-rhenium is not practical for long term measurement around 2000°C. They often fail owing to the friction created by the different thermal expansions of the thermocouple wire and insulators during the heat cycles.

From research on the degradation of thermocouples, it was found that degrading factors can be removed by improving the construction of thermocouples units. Since it is difficult to obtain a reliable temperature measurement above 2000°C, and especially above 2200°C, with a thermocouple made from tungsten-rhenium alloys, improvement of other technology is necessary.

Various principles can be used for high temperature measurement, but only a few can be applied to high-pressure in HIP equipment. The optical method, which uses thermal electromagnetic radiation, seems to be the most suitable for the following reasons: (i) the principle is very simple (temperature can be easily calculated by Planck's equation), (ii) temperature measurement of 2200°C or higher is easily performed (no upper limit exist), and (iii) no degradation can occur.

The first trial application of the optical method to temperature measurement for HIP equipment was done at Battelle Memorial Institute in 1965 [41]. Fig. 3 shows the schematic diagram of optical method. A single unit consists of a pipe closed at the upper end, which corresponds to the temperature measuring point.

The same figure, also shows a special instrument which gathers radiant energy without pressure dependence from the closed upper end, an optical fiber for the lead-through which carries the radiant energy gathered by the optical instrument, and a radiamatic thermometer unit which is either an optical pyrometer or a two colour thermometer.

With the purpose to obtain temperature uniformity, a heating device is usually separated into several zones, then the power is applied to each zone and controlled independently. The most important safety feature of optical method is the sealing technology for the optical fiber [1]. So far, no leakage was detected in over one hundred runs at 100 MPa. Using the optical method and high temperature HIP furnace technology, a super high-temperature HIP unit was developed. This furnace has a capability of operating at 2600°C and 200 MPa. The temperature control of this furnace is accomplished

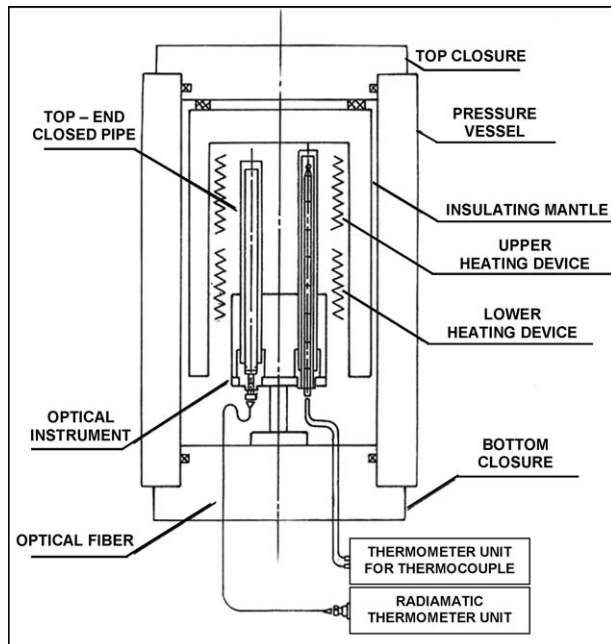

Figure 3 Schematic diagram of optical method [From ref. 1].

by the optical method. Likewise, HIP units of a maximum 1 GPa ($1.02 \times 10^4 \text{ kgf} \cdot \text{cm}^{-2}$) \times 1600°C and 980 MPa ($1.0 \times 10^4 \text{ kgf} \cdot \text{cm}^{-2}$) \times 2000°C has already been manufactured.

Due to its inertness, argon is the most popular pressure transmitting medium for HIP. But, when HIPing nitride ceramics such as Si_3N_4 without encapsulation, most of the nitride ceramics partly decompose under an argon atmosphere at high temperature. Owing to this reason, the use of nitrogen instead of argon [42–44] gives better results, because high pressure nitrogen suppresses the decomposition of nitrides.

Equally, some oxides became volatile under a high pressure nitrogen atmosphere and the deposition of these substances often causes the failure of the furnace structure. To adjust this, the oxygen concentration in the nitrogen gas must be taken into account and the use of oxide ceramic insulators in the hot section is not desirable [9, 19].

3. HIP applications in high performance metals and ceramics

Among the high performance ceramics gaining attention in recent years, PSZ, Si_3N_4 and SiC are the first three materials used for structural applications [1, 13, 14, 27]. Likewise, the HIP process is used for densifying castings, component repair and powder metal consolidation as well as creation of PM shapes.

In Hot Isostatic Pressing process, three routes can be adopted. These are: (i) encapsulation method, (ii) glass bath method, and (iii) sinter-plus HIP method. The schematic diagram of these methods is shown in Fig. 4.

3.1. The “Encapsulation” and “Capsule free” method

A basic requirement for HIPing previously shaped ceramic parts is the encapsulation of the green porous compact, for interface bonding and in some cases for the sealing of surface-connected porosity so that a deformable gas impermeable membrane forms around it, at the processing temperature, and acts by transmitting the applied isostatic pressure. The basic requirements for the envelope are that it should be relatively strong, gas tight, inert and plastic under the applied temperature and pressure conditions, compatible with the material to be pressed in order to minimize diffusion reactions and readily removable [35]. Likewise, full densification is possible without or with only small amounts of the additives. Typically, the encapsulation method involves enclosing the green compact in either a metallic container or a glass ampoule, although a few reports on the use of a glass powder encapsulation have also been reported [19, 45, 46]. Fig. 5 shows a schematic drawing for encapsulation method.

In addition, up to now, refractory metals such as tantalum, molybdenum, tungsten have been used [1, 33, 36] as well as mild steel, stainless steel or nickel alloys. They are spun, superplastically formed or fabricated by conventional means into the required shape for powder containment [35]. Using this technique, the work-piece is embedded into boron nitride powder by cold

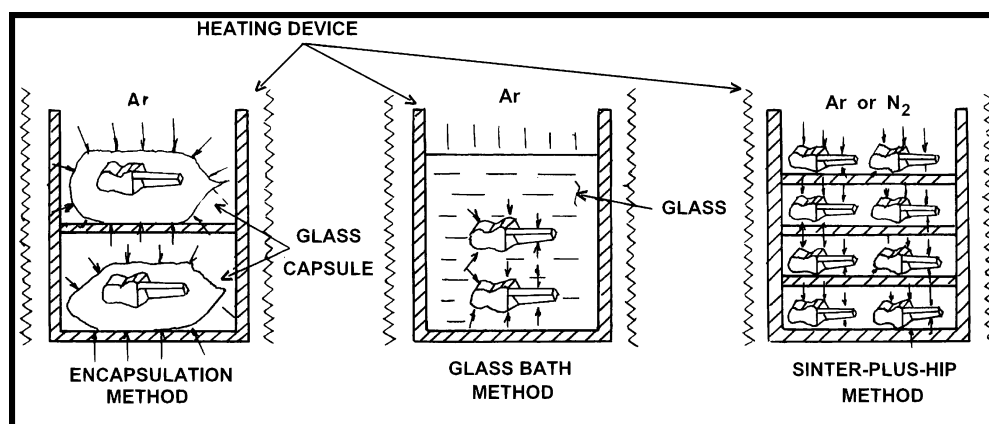

Figure 4 Possible routes for the production of dense ceramics [From ref. 19]. Reprinted from T. Fujikawa, M. Moritoki and T. Kanda, “Hot Isostatic Pressing: Its Application in High Performance Ceramics,” Proceedings of International Symposium on Ceramic Components for Engine, Japan, 1983, page 425–433, with permission of Scipress Publishers.

Capsule method

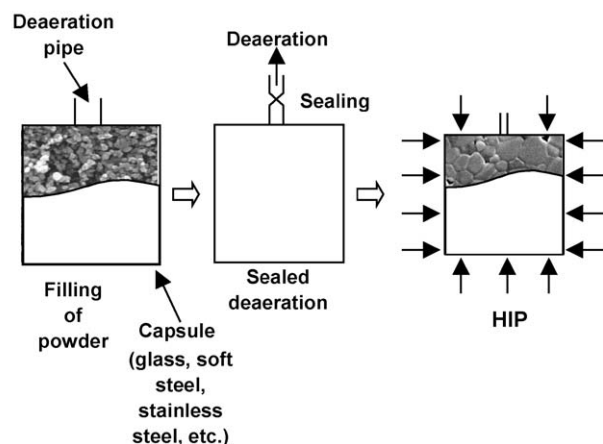

Figure 5 Schematic drawing of encapsulation method [From ref. 7].

isostatic pressing. After this, the compact is encapsulated usually in a silica glass tube. The boron nitride powder acts in this case as a pressure transmitter avoiding stress and reaction zones [45].

In order to utilize the glass encapsulation method for commercial production ceramics, many problems need to be solved. For example; (i) encapsulation of large parts, (ii) prevention of the reaction between the product and the container material, (iii) decapsulation without causing any damage to the product, (iv) control of the microstructure in order to achieve the desirable mechanical or physical properties, and (v) economy.

On the other hand, the encapsulation method has a great advantage in that any material can be highly densified, but it has a long way to go to commercial utilization owing to the above mentioned problems [1, 9, 47, 48]. As an example, the Table I summarizes the results using this method. The container material used, was either silica or Pyrex glass, and the evacuation prior to the encapsulation was performed at 1500°C for the silica glass containers and 700°C for the Pyrex glass. In this table, all specimens were highly densified but not to their theoretical density [9]. The glass encapsulation technique developed at ASEA Cerama allows mass production at competitive prices [49–51]. The Table II summarizes main features of the glass encapsulated Hot Isostatic Pressing technique. After HIP processes, the sealing glass used was removed by sand blasting.

It is necessary to pay attention to the handling pattern of temperature and pressure. If HIP is carried out using the “encapsulation method”, normally a temperature

TABLE I Results of HIP densification by encapsulation method for different powders [From ref. 9]

Powder	Capsule	HIP			Relative density (% T.D.)
		Pres. (MPa)	Temp. (°C)	Time (h)	
Si ₃ N ₄	Pyrex	80	1800	1	97.0
BN	Silica	145	1850	1	97.1
TiN	Silica	145	1850	1	98.9
SiC	Silica	145	1850	1	87.0
B ₄ C	Pyrex	90	1900	1	96.3
TiC	Pyrex	90	1900	1	93.0

TABLE II Main features of the glass encapsulated HIP technique [From ref. 51]. Reprinted from Materials and Design, Vol. 8, No. 4, J. Adlerborn, M. Burström, L. Hermansson and H.T. Larker, “Development of High Temperature High Strength Silicon Nitride by Glass Encapsulated Hot Isostatic Pressing”, pages 229–232, Copyright 1987, with permission from Elsevier.

Flexibility in composition

- Highly covalent bonded compounds (Si₃N₄, SiC, B₄C, etc.) can be processed.
- Undoped or low-doped materials can be completely densified
- Development of composite materials with high load of whiskers/fibers is facilitated by the high pressure during densification
- The glass encapsulation technique has been developed for general use of ceramics (nitrides, carbides, borides and oxides)

Flexibility in volume and geometry

- Extremely large and complex shapes can be processed with a minimum of post-machining
- High tolerances are achieved due to the iso-shrinkage condition during densification
- Mass production capability developed.

Consistency in material properties

- Completely dense materials are obtained with a density variation in the order of 0.0001 g·cm⁻³.
- No weight loss during densification
- Improved high temperature strength
- Improved resistance towards degradation mechanisms such as slow crack growth and creep
- Improved grain growth control due to the lower densification temperature (200–500°C than in conventional sintering)
- High yield mainly related to the possibility of crack healing in green compacts.

preceding pattern is used. If pressurized before the softening of the capsule material, damages may occur due to the fact that the deformable ability of the capsule is small. In case of a capsule made from mild steel, it will be pressurized after heating up until approximately 800°C at nearly atmospheric pressure [7]. For further reference, the HIP treatment material and the treatment temperature/pressure applied to it are illustrated by the example in Table III.

On the other hand, the Fig. 6 shows the concept of the “capsule free method”. If the pores within the material to be treated are isolated, they may be squashed by

TABLE III Major materials to HIP and HIP temperatures and pressure [From ref. 7]

Materials to HIP	Temperature (°C)	Pressure (MPa)
High-speed steel powder	1.000–1.200	~100
Ni base superalloy	1.170–1.280	100–150
Ti alloy (Ti-6Al-4V)	800–960	~100
Cr	1.200–1.300	~100
Cu alloy	500–900	~100
Al alloy	350–500	~100
Cemented carbide (WC-Co)	1.300–1.350	30–100
TiBaO ₃	100–1.200	~100
PZT	950–1.150	~100
Ni-Zn-ferrite	1.050–1.180	~100
Mn-Zn-ferrite	1.180–1.250	~100
Al ₂ O ₃	1.350–1.450	~100
Y-PSZ (Yttria partially stabilized zirconia)	1.350–1.500	~100
Si ₃ N ₄ -Al ₂ O ₃ -Y ₂ O ₃	1.700–1.800	~100
SiC	1.950–1.050	100–200

Capsule-free method

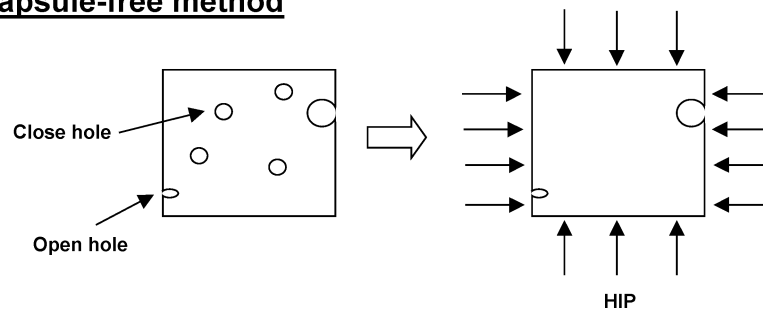

Figure 6 Schematic of capsule free method [From ref. 7].

HIP and eliminated by the diffusion process. However if the pores within the material to be treated are not isolated, they may not be squashed by HIP nor eliminated. Therefore if all pores are isolated, the HIP effect brings them out and high densification is possible. The “capsule free method” is used for removing defects, removing internal casting defects (such as shrinkage or porosity, which are considered problems), and reproduction of worn out parts [7]. This method [8] is excellent in productivity but requires the preparation of high-dense sintered body before HIP. Therefore cannot be applied to the powder (spherical powder and ceramics difficult to sinter). HIP has been applied to various alloy castings, especially in the field of aircraft parts, such as Ni-based super heat resistance alloy or Ti alloy.

3.2. The glass bath method

In this method [19], a porous body is processed while immersed in powdered glass with a low softening temperature. Its features are almost the same as those of encapsulation method except that the complicated encapsulation technique is not necessary. The disadvantages are as follows: the low density green body has a tendency to float upon the melted glass, so some means of sustaining the workpiece under the free surface of the glass is indispensable. Likewise as low softening temperature glasses often penetrate into the pores of the workpiece, a coating of a special material must be put over entire surface of the workpiece.

3.3. The sinter-plus HIP method

The sinter-plus HIP method was thought to be more practicable for commercial production of Si_3N_4 parts with high reliability [9, 29, 52, 53]. Alumina cutting tools, soft ferrites for magnetic recording heads and piezoelectric materials for surface acoustic wave filters have already been produced via the sinter + HIP method. To produce components having a complex shape [54, 55], sinter-plus-HIP is another route which involves processing of non-encapsulated green compacts while the benefits of the application of high pressure during consolidation can still be obtained in this method. The green compacts are sintered and subsequently hot isostatically pressed during the same cycle [10, 16, 29, 52, 56–61].

The model program to carry out “sinter + HIP” processing of Si_3N_4 materials is shown in Fig. 7 us-

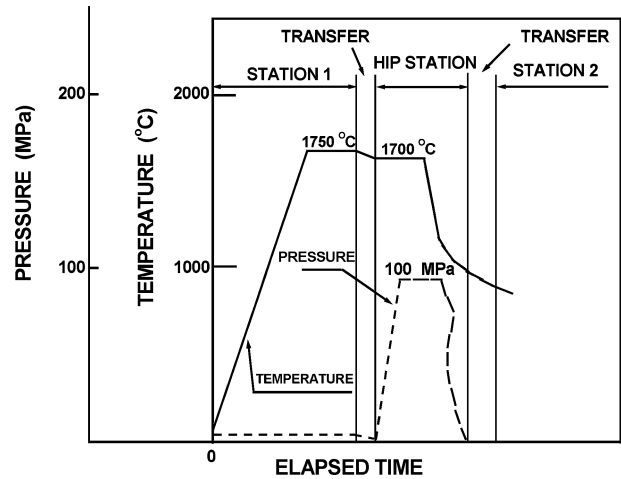

Figure 7 Typical pressure and temperature pattern for Sinter + HIP process with modular system [From ref. 1].

ing modular HIP system [1]. The essential requirements of a furnace operating under this program are: (i) rating up to 1700°C in nitrogen at one atmosphere of pressure, and at 100 MPa as well, and (ii) maintaining the desired atmosphere inside of furnace (in this case, a nitrogen atmosphere during transfer from one station to another). This type of high temperature modular HIP system will certainly be one type of HIP equipment for future ceramic processing.

With this method, a large quantity of a small parts which have isotropic mechanical properties and high reliability can be produced easily. Now, the shrinkage with the “sinter-plus-HIP” processes is so little that high packing density in the HIP furnace can be expected. The only disadvantage is that it requires a sintering stage prior to the HIP processing. As an example [19], the manufacturing flow sheet for silicon nitride parts, including not fully dense ones, is summarized in Fig. 8. In this figure, the glass bath method is not shown, but its flow sheet will be the same as for encapsulation method except for the encapsulation stage.

In the field of metals, sintering is the process that converts green carbide to cemented carbide, for example. This process involves melting a metal binder, allowing the binder to flow around the essentially solid tungsten carbide particles and then cooling the material to allow the binder to solidify. The result is a hard, durable cemented carbide product. Sinter-HIP is most useful for

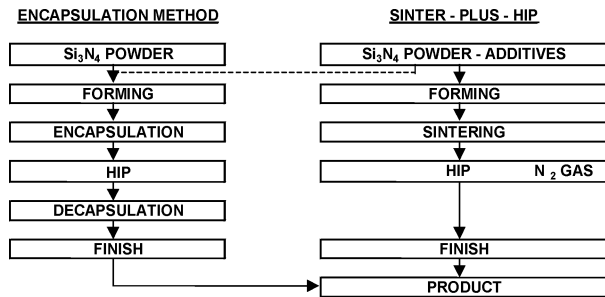

Figure 8 Manufacturing flow sheet for silicon nitride parts [From ref. 19]. Reprinted from T. Fujikawa, M. Moritoki and T. Kanda, "Hot Isostatic Pressing: Its Application in High Performance Ceramics," Proceedings of International Symposium on Ceramic Components for Engine, Japan, 1983, page 425-433, with permission of Scipress Publishers.

low metal binder grades (<8%). Conventional sintering and HIP processes are generally sufficient for higher binder grades. Likewise, sinter-HIP will not fill voids or cracks that have reached the surface of a part.

3.4. High pressure reaction sintering method

However, it is important to stress that in the case of silicon nitride, in addition to above three routes, reaction sintering can be performed utilizing high pressure nitrogen gas in the HIP equipment [19, 42, 44]. The advantage over conventional reaction sintering is that the cycle time could be shortened by effect of high pressure itself and by the rapid dissipation of reaction heat due to the natural convection. The typical pressure and temperature schedule is shown in Fig. 9. Fig. 10 shows the manufacturing flow sheet for this method applied to silicon nitride parts. In contrast to conventional reaction sintering in which the cycle time usually exceeds 30 h, in high pressure reaction sintering, the cycle time can be reduced about third.

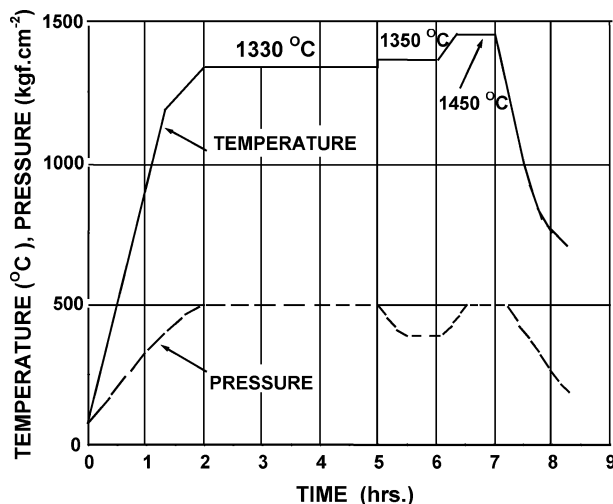

Figure 9 Typical pressure and temperature schedule [From ref. 19]. Reprinted from T. Fujikawa, M. Moritoki and T. Kanda, "Hot Isostatic Pressing: Its Application in High Performance Ceramics," Proceedings of International Symposium on Ceramic Components for Engine, Japan, 1983, page 425-433, with permission of Scipress Publishers.

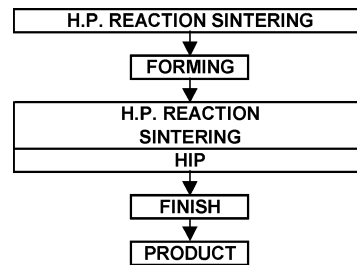

Figure 10 Schematic diagram for manufacturing silicon nitride parts [From ref. 19]. Reprinted from T. Fujikawa, M. Moritoki and T. Kanda, "Hot Isostatic Pressing: Its Application in High Performance Ceramics," Proceedings of International Symposium on Ceramic Components for Engine, Japan, 1983, page 425-433, with permission of Scipress Publishers.

3.5. Liquid-HIP method

One of the disadvantages of the HIP process is its cycle time, namely its productivity. Nonetheless, intensive efforts have been made to shorten the cycle time and some companies have already been using pre-heating HIP process. Nevertheless, the cycle is still on the order of five hours or so. Recently, liquid-HIP, in which pre-heated capsules are compressed in a visco-plastic pressure medium such as oil/grease, has been developed [24], as shown schematically in Fig. 11.

Taking into account that the conventional HIP process, which uses gas to apply high pressure for closing internal porosity, is very effective, but very dangerous and costly—too much so for the commercial applications, recently MC-USA and Teksid-Italy [62], developed and industrialized for metals, in partnership with Idrax-Italy a new hot isostatic pressing process, called liquid HIP (LHIP), where the mean used to apply the pressure to the components to be treated is a liquid salt, with a much higher density than argon at process temperature, and so it is able to reach high pressures in a shorter time [63] as shown in Figs 12 and 13. The process can be considered a technology breakthrough. Its cost competitiveness will open a bright future in the next few years for HIP applied to aluminum automotive components for mass production, with the goal of having higher properties on treated parts and reduced

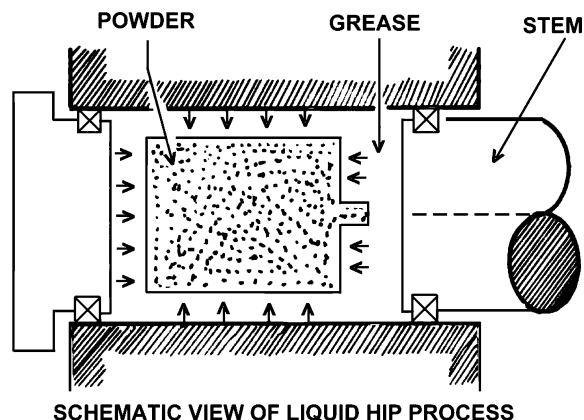

Figure 11 Schematic view of liquid-HIP process [From ref. 24]. Reprinted from T. Fujikawa and N. Kawai, "Recent Trends in HIP Process Technology in Japan," 2nd International Conference on Hot Isostatic Pressing—Theory and Applications, Maryland, USA, June 1989, pages No. 1-6, with permission of ASM International.

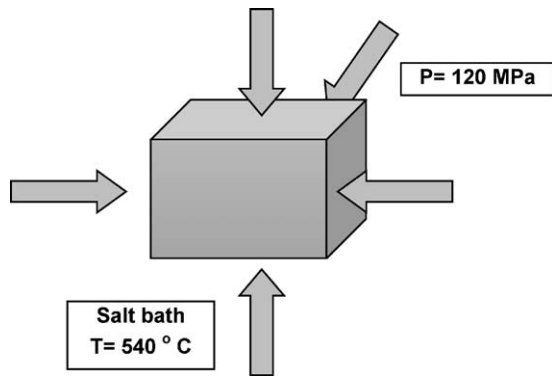

Figure 12 Scheme of an element of material, which is subjected to LHIP in a melted salt bath [From ref. 63]. Reprinted from Metallurgical Science and Technology, Vol. 19, No. 1, June 2001, E. Romano, M. Rosso and C. Mus, "The Effect of Liquid Hot Isostatic Pressing on Fatigue Properties of Al Based Castings," Pages No. 21–27, Copyright 2001, with permission from Teksid S.p.A.

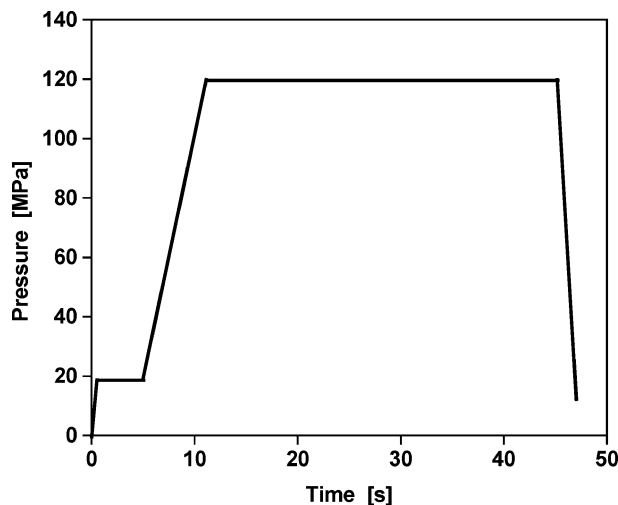

Figure 13 Pressure in function of time during LHIP process [From ref. 63]. Reprinted from Metallurgical Science and Technology, Vol. 19, No. 1, June 2001, E. Romano, M. Rosso and C. Mus, "The Effect of Liquid Hot Isostatic Pressing on Fatigue Properties of Al Based Castings," Pages No. 21–27, Copyright 2001, with permission from Teksid S.p.A.

scrap level in the casting process chain. LHIP completely eliminates porosity in castings and gives from 50 to 100% increases in ductility and fatigue life [64].

The process principle is based on the idea of applying the isostatic pressure over the casting through a liquid instead of a gas to overcome de HIP cost process issues. It can be easily understood that the cycle time can be dramatically reduced (from hours to minutes) and the risk of explosion of the high pressure working vessel can be reduced to zero (the liquid pressure will immediately drop in case of leakage or failure) [62, 65].

The selected liquid has to meet the following requirements: (i) low cost, (ii) recyclable and easily washable, (iii) non corrosive for the aluminum alloys and for the vessel material, (iv) melting point at low temperature (250–300°C), and (v) boiling point at high temperature (above 600°C).

After a long period dedicated to the testing of different solutions, a family of salts has been identified and technical solutions have been defined to guarantee the vessel tightness under the operating conditions as outlined in Fig. 14.

Like the HIP process LHIP eliminates some of the typical casting defects like micro and macro shrinkage porosity and hydrogen inclusion. Defects connected with the surface (i.e., cold shots, surface cracks), as well as nitrogen inclusions and oxides, cannot be eliminated: these kind of defects can be slightly modified in shape. In summary, diffusion bonding does not occur when metal/metal contact is obstructed, if for example the surfaces of the defect are oxidized or if there is a gas inside the pore that does not diffuse, e.g., air. In the Figs 15 and 16 the possible situations are shown [63]. Process normal running parameters to obtain such results on A356 aluminum castings (for example) are: (i) 1000–2000 ATM pressure, (ii) 500–540°C salt temperature, (iii) 20–35 s pressure applied, and (iv) 3–4 min total cycle time (including heating and cooling).

The LHIP effect on the microstructure of the treated castings improves the material mechanical properties and increases density (see Fig. 17).

3.6. HIP diffusion bonding

Bonding methods for materials are classified into: (i) fusion welding to fuse bonding parts, (ii) solid phase bonding to bond parts without fusing, and (iii) waxing to bond parts using liquid metal. Diffusion bonding is a kind of solid phase bonding that is used to bond using a slight plastic and worn out deformation by heat and pressure and using atomic diffusion [7].

Diffusion bonding using HIP has been considered an ideal process for the manufacture of parts with a curved interface [24, 28,] as well as to join dissimilar materials that cannot be joined by traditional fusion methods such as welding. Historically, it was a need for interfacial bonding which led to the development of the HIPing process itself. The Battelle Institute of the USA designed one of the first HIPing vessels in the late 1950s in order to diffusion bond Zircalloy cladding to uranium oxide nuclear fuel [67].

On the other hand, because HIP can pressurize at high isostatic pressures, it can: (i) completely bond a large surface, (ii) bond a wide direction of surfaces at the same time, (iii) bond a curved surface, (iv) bond powder materials (bond powder materials at the same time with a pressure sintering), (v) bond with yielding, (vi) bond brittle materials, and (vii) improve the property of base materials at the same time with bonding (bond sintering products at the same time as removing pore defects) [7, 24].

The schematic illustration of high performance products developed by HIP diffusion bonding processing [68, 69] is shown in Fig. 18. Then, through these processes, the products are sintered, densified, and stiffly bonded to the base material.

A type of diffusion bonding process for metallic materials is shown in Fig. 19 [7]. Generally, as the Fig. 19a shows, the surface of a material processed by a machine has an unevenness of the order of several μm to several ten μm and an oxidized membrane also exists. When hot pressurized, as Fig. 19b shows, this material will be increased its contact area by yielding. If such status holds, as Fig. 19c shows, air

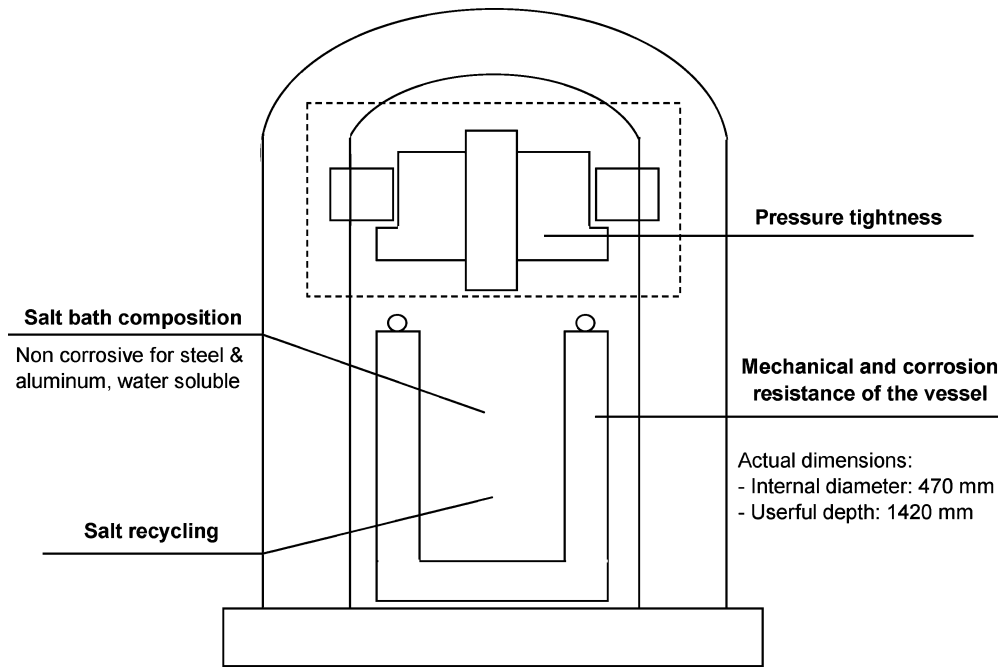

Figure 14 LHIP schematic concept [From ref. 66]. Reprinted from Metallurgical Science and Technology, Vol. 19, No. 1, June 2001, S. Gallo, C. Mus and G. Mortari, "Reasons to Develop Liquid Hot Isostatic Pressing," Pages No. 16–20, Copyright 2001, with permission from Teksid S.p.A.

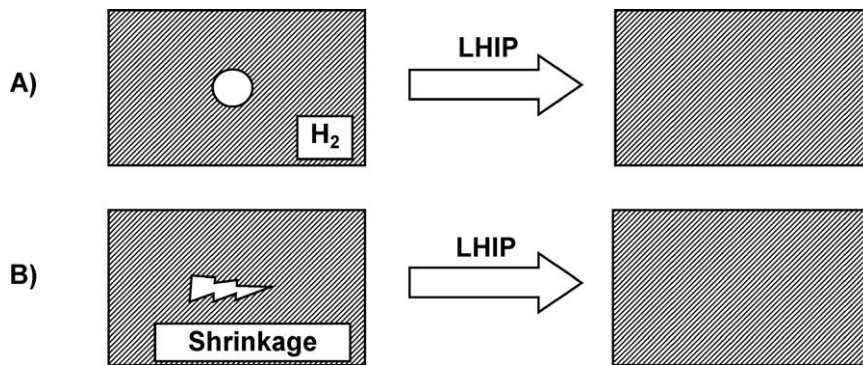

Figure 15 Defects, which can be closed after LHIP; (a) H₂ Pore, (b) Solidification shrinkage [From ref. 63]. Reprinted from Metallurgical Science and Technology, Vol. 19, No. 1, June 2001, E. Romano, M. Rosso and C. Mus, "The Effect of Liquid Hot Isostatic Pressing on Fatigue Properties of Al Based Castings," Pages No. 21–27, Copyright 2001, with permission from Teksid S.p.A.

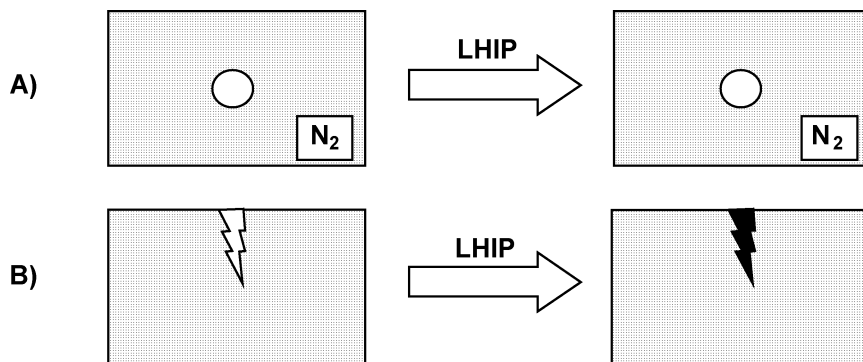

Figure 16 Defects, which can not be closed after LHIP; (a) Air entrapped, (b) Surface porosity [From ref. 63]. Reprinted from Metallurgical Science and Technology, Vol. 19, No. 1, June 2001, E. Romano, M. Rosso and C. Mus, "The Effect of Liquid Hot Isostatic Pressing on Fatigue Properties of Al Based Castings," Pages No. 21–27, Copyright 2001, with permission from Teksid S.p.A.

space on the bonding face will be shrunk by the worn out deformation and a part of the oxidized membrane will be destroyed, then atomic diffusion will occur. Finally, as Fig. 19d shows, a stable bonding face will be formed.

However, some combinations are difficult to bond. The Fig. 20 shows some combinations of materials generally thought to be possible [7]. The figure shows that the bonding of similar materials is possible. Besides, among the bonding of different materials, it is

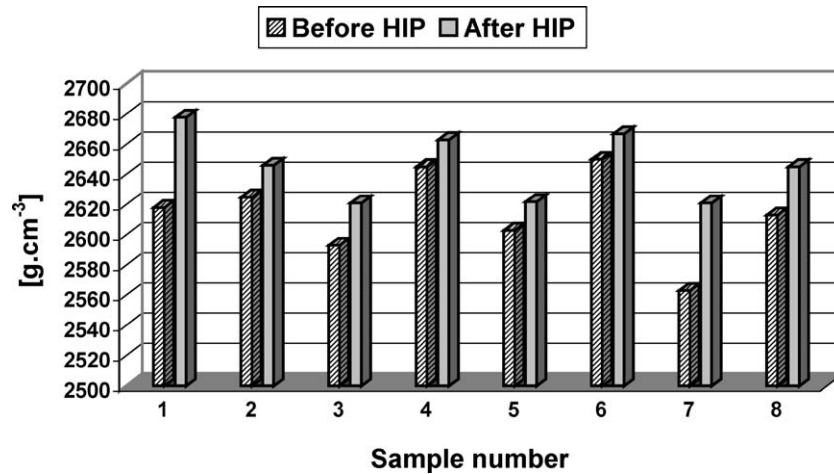

Figure 17 Comparison of suspension arms density before and after LHIP treatment of cast AA356 [From ref. 66]. Reprinted from Metallurgical Science and Technology, Vol. 19, No. 1, June 2001, S. Gallo, C. Mus and G. Mortari, "Reasons to Develop Liquid Hot Isostatic Pressing," Pages No. 16–20, Copyright 2001, with permission from Teksid S.p.A.

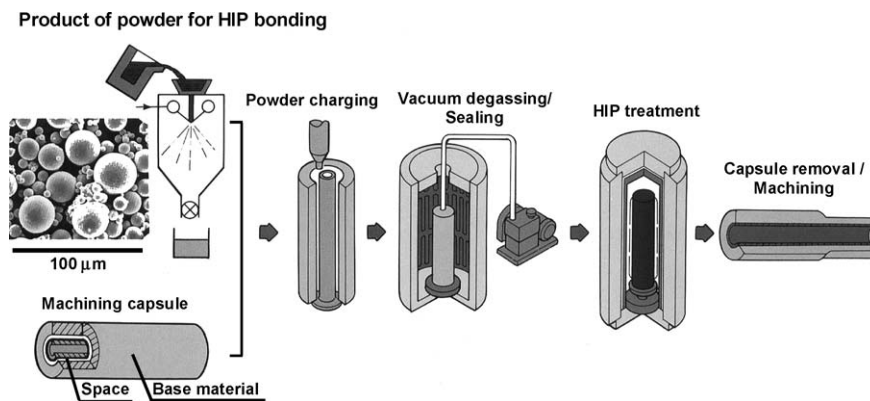

Figure 18 Schematic illustration of HIP diffusion bonding [From ref. 68].

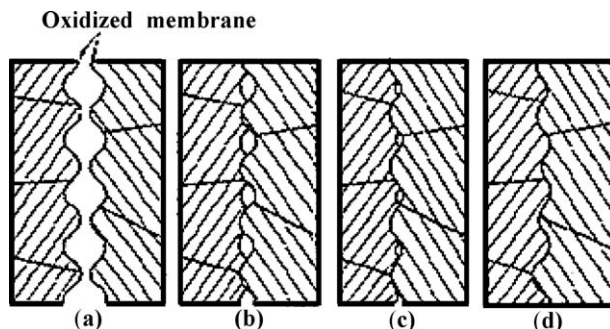

Figure 19 A type of diffusion bonding process for metallic materials [From ref. 7].

comparatively easy to bond Ni alloy, Cu alloy, Zr alloy with other metallic materials.

4. Other technologies derived from HIP

As mentioned previously, HIP produces a high isostatic pressure and high temperature atmosphere through using gas as a pressure medium. Taking these advantages into consideration, the following sintering processes have lately been researched: (i) controlled-atmosphere sintering, where the sintering is carried out using argon/oxygen mixed gas as its pressure medium in order to do the HIP treatment, then to actively avail the re-

action between these gases and a workpiece. Oxygen-contained atmosphere HIP, can prevent oxide ceramics surfaces from being oxygen deficient (reduced reaction). Besides nitrogen atmosphere HIP is said to be effective for the prevention of thermolysis of nitrogen ceramics [7], and (ii) pressurized combustion sintering, where this is a new sintering process combining a combustion combination method, which is a heat generating reaction of compounds, with a pressure means to combine ceramics or intermetallic compounds, etc., from raw powder and densifying them at the same time [7]. Fig. 21 gives a concept of this process. When availing of HIP as a means of pressure for densification, the Net-Near Shape sinter can be produced from raw materials in one process.

5. Experimental results

Some experimental results from different authors on the application of HIP to ceramics such as silicon nitride, silicon carbide, aluminum oxide, Y-PSZ and some metallic materials, are now summarized.

5.1. Silicon nitride (Si₃N₄)

Silicon nitride refers to an alloy family of ceramics whose primary constituent is Si₃N₄. The combination

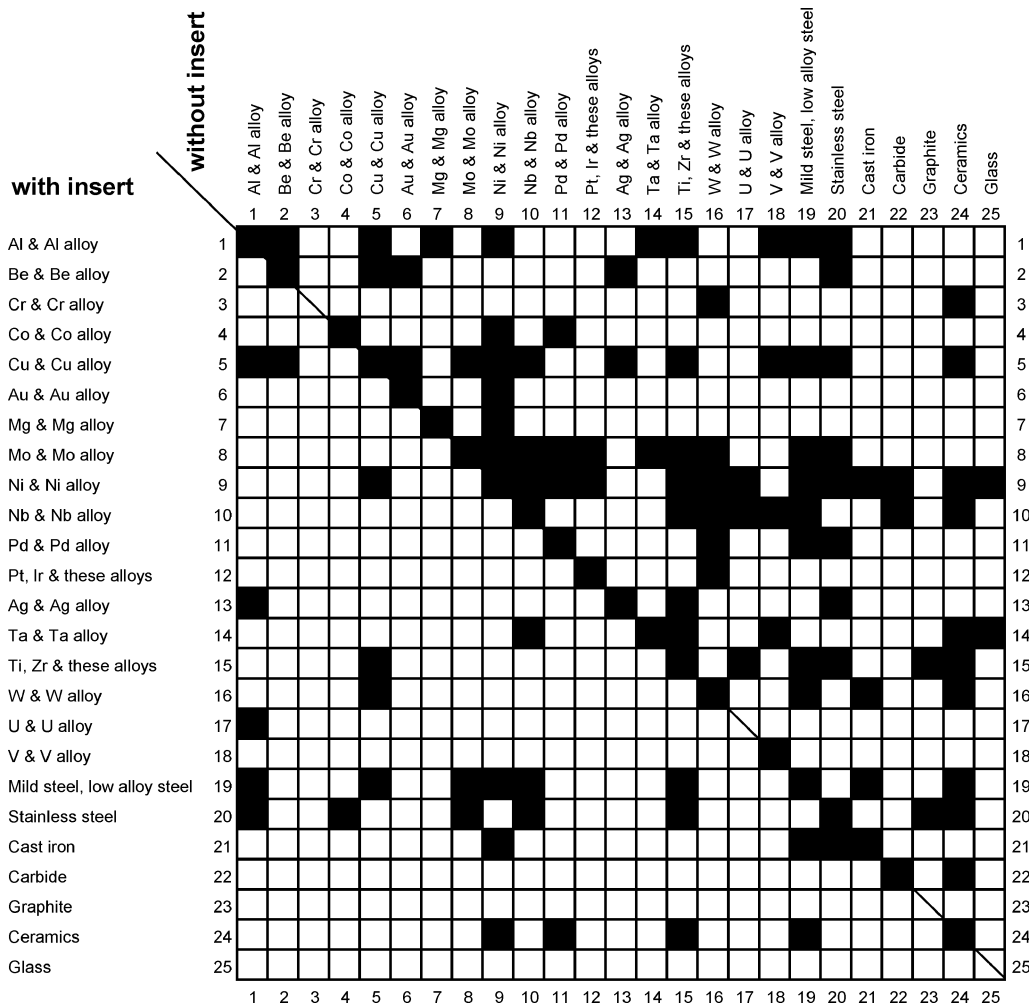

Figure 20 Combinations of materials to be bound (■: possible) [From ref. 7].

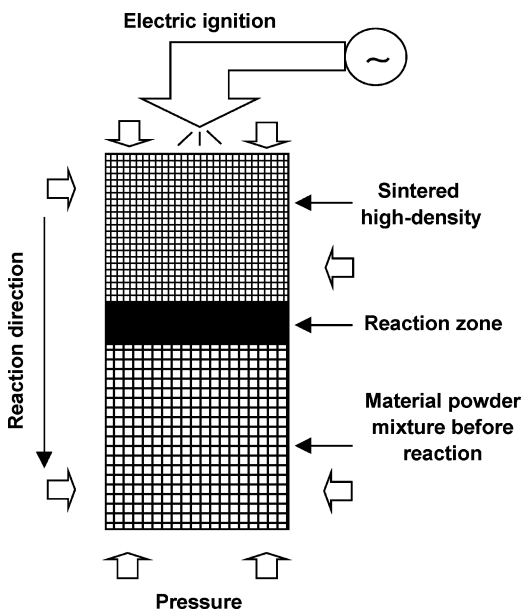

Figure 21 High pressure self-combustion process [From ref. 7].

of properties such as high strength over a broad temperature range, high hardness, moderate thermal conductivity, low coefficient of thermal expansion leads to excellent thermal shock resistance, ability to withstand high structural loads to high temperature and superior

wear resistance [70, 71]. Today, the application of HIP to silicon nitride has been of particular interest for researchers and manufactures of this material because HIP surpasses conventional methods in (i) full densification of silicon nitride without the additives that often, degrade its high-temperature strength, and (ii) enhancement of the Weibull modulus, that is, improvement of reliability.

A plot of bulk density against temperature of undoped and 1 w/o Y_2O_3 doped silicon nitride is shown in Fig. 22. For the undoped material the presence of a silicate liquid is confirmed by the increase in density which is apparent at temperatures as low as $1600^\circ C$.

This result indicates, firstly, that as suggested before [72, 73], the impurities may play an important role in decreasing the melting temperature of silica and secondly, that this increase in density is probably related to rearrangement of α -particles since, up to $\approx 1700^\circ C$, no further increase in density was observed and only minor quantities of β - Si_3N_4 originated from the α - β transformation were detected by XRD.

The Fig. 23a and b shows the microstructure of undoped silicon nitride after Hipping at $1950^\circ C$ in argon gas. Examination at higher magnifications of this sample, disclosed the presence of a discontinuous silicon-rich intergranular glassy phase.

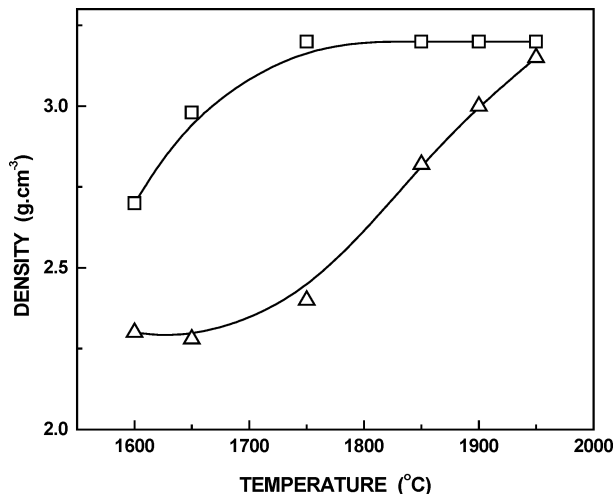

Figure 22 Dependence of bulk density on temperature for (Δ) undoped and (\square) 1w/o Y_2O_3 doped silicon nitride after HIPing for 2 h under the application of 150 MPa gas pressure [From ref. 74].

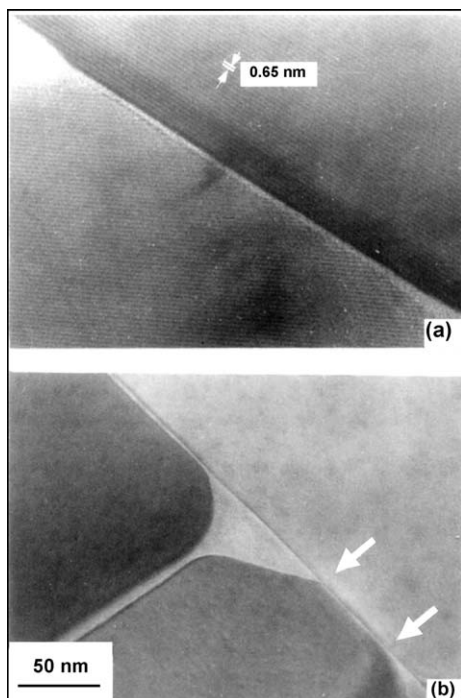

Figure 23 Transmission electron micrographs of undoped silicon nitride after HIPing at 1950°C; showing (a) $\{1010\}$ lattice planes in β - Si_3N_4 and intergranular phase from the area indicated in (b), and (b) β - Si_3N_4 grains and the intergranular SiO_2 -based phase [From ref. 74].

The presence of this secondary phase is obviously owing to the silica covering the original Si_3N_4 particles which amounts, in this particular high surface area ($\approx 20 \text{ m}^2 \cdot \text{g}^{-1}$) silicon nitride powder, to a total of approximately 3.7% wt. In Fig. 23, the intergranular phase shows up in light contrast and was mainly observed at some triple points, but was also formed as very narrow strips (a few atomic planes in width) separating some nitride grains [74].

The possibility of HIP densification of sintered silicon nitride has been examined, especially that focussed on the effect N_2 gas on the suppression of the decomposition of silicon nitride at the HIPing stage [42, 44]. Results of the density measurement before and after

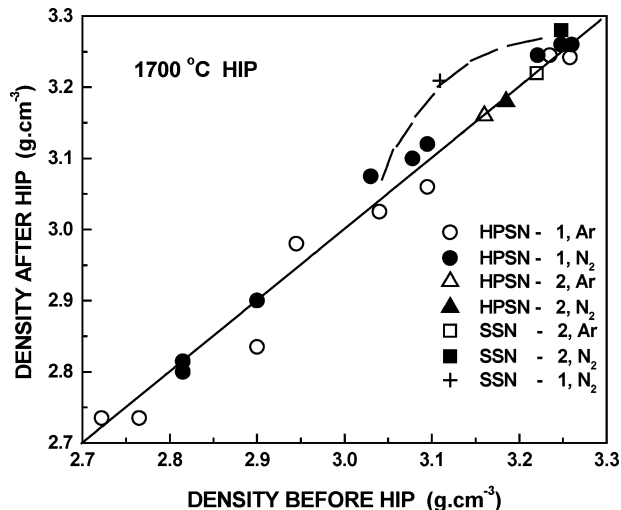

Figure 24 Effect of HIPing on density (temperature 1700°C). HPSN: Hot pressed silicon nitride; SSN: Sintered silicon nitride [From ref. 9].

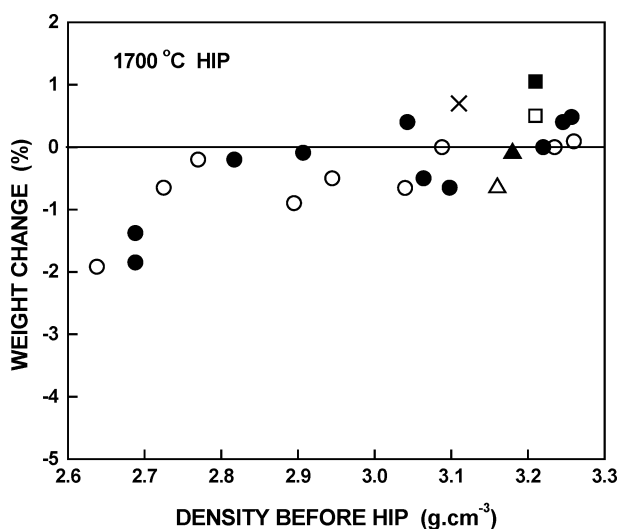

Figure 25 Weight Change of Si_3N_4 (temperature 1700°C) (The same mark as figure 24) [From ref. 9].

HIPing are shown for 1700°C in Fig. 24. When the density before HIPing is less than $3.0 \text{ g} \cdot \text{cm}^{-3}$, the density after HIPing under argon gas scatters, while an increase is observed under N_2 gas.

On the other hand, it is difficult to get highly interlocked beta- Si_3N_4 microstructure during pressureless sintering due to the decomposition above 1800°C, however, gas pressure sintering could solve this problem by increasing the densification temperature. 2 MPa of nitrogen pressure was enough to inhibit the decomposition up to 1800°C [42].

Now, in Fig. 25, the weight change before and after HIPing is shown. Weight loss due to decomposition of silicon nitride decreases as the density before HIPing approaches its maximum density (3.22–3.26).

Concerning the mechanical properties, the measured flexural strength of the A and D samples (α -phase: 94 and 98% respectively) prepared by HIPing at 2000°C is shown in Fig. 26 as a function of testing temperature. The A and D samples showed a tendency toward enhancement of flexural strength with increasing temperature. Particularly, the D sample, which was found to

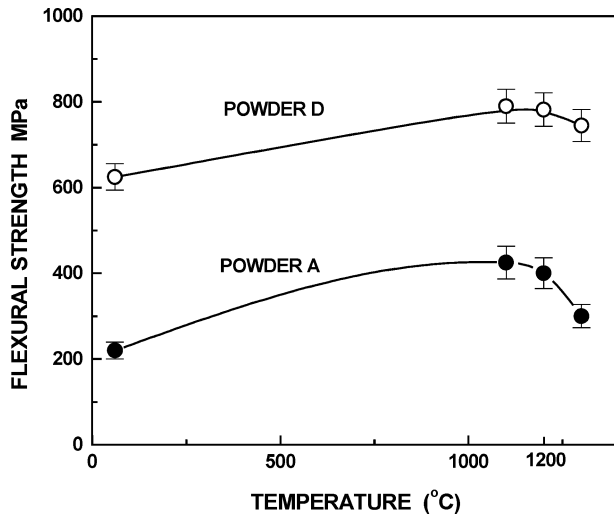

Figure 26 Flexural strength of Si_3N_4 without additives (HIP: $2000^\circ\text{C} \times 150 \text{ MPa}$) [From ref. 32].

retain strength as high as 735 MPa at 1400°C showed no remarkable degradation in strength in comparison with the equivalent at 1300°C , which may be considered excellent performance for a silicon nitride material [32]. The inferiority in strength of the A sample is attributable to the extraneous material portion originating from metallic impurities having dimensions of 50 to $100 \mu\text{m}$ and a relatively lower melting point [32]. A trend to the enhancement of flexural strength up to approximately 1200°C seen commonly in the A and D samples may be attributed to the grain boundary glassy phase becoming soft such temperatures, giving rise to an apparent enhancement of K_{IC} .

It is clear that N_2 -HIPing was better than Ar-HIPing for densification of silicon nitride, because high pressure N_2 gas suppressed the decomposition of Si_3N_4 . Moreover, it became clear that N_2 HIPing was also available for healing of internal defect in silicon nitride originated during cold pressing or sintering. For instance [22], ultrasonic testing showed that a lamination crack in the specimen of sintered silicon nitride-1 (SSN-1) which was 20 mm in diameter and 15 mm in height, was eliminated by N_2 -HIPing. Equally, the flexural strength of N_2 -HIPing was higher than Ar-HIPing and it is noted that the improvement of strength [11, 12, 44] depends on the kinds of pre-sintered Si_3N_4 in case of N_2 -HIPing as show in Fig. 27 corresponding to ceramics quoted in Table IV. For example, the strength of HPSN-1 or SSN-1 was considerably increased but that of SSN-2 or RBSN-1 was not. It is assumed that existence of the needle-like crystallites was necessary

TABLE IV Pre-sintered Si_3N_4 used for HIP process

Sample	Additive	Density ($\text{g} \cdot \text{cm}^{-3}$)
HPSN-1	6% Y_2O_3 -2% Al_2O_3	2.64 \approx 3.25
SSN-1	6% Y_2O_3 -2% Al_2O_3 -3% MgO	3.05 \approx 3.22
SSN-2 ^a	Unknown	3.16 \approx 3.21
RBSN-1 ^a	Unknown	2.94

HPSN: Hot pressed Si_3N_4 ; SSN: Sintered Si_3N_4 ; RBSN: Reaction bonded Si_3N_4 .

^aCommercial Ceramics [From ref. 22].

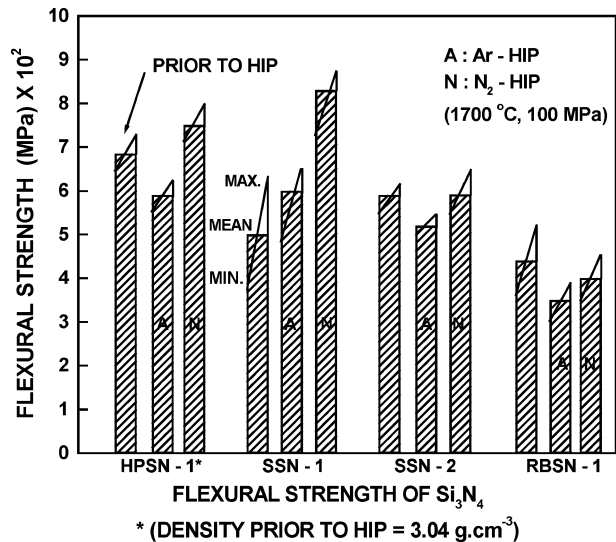

Figure 27 Flexural strength of Si_3N_4 (*density prior to HIP = $3.04 \text{ g} \cdot \text{cm}^{-3}$) [From ref. 9].

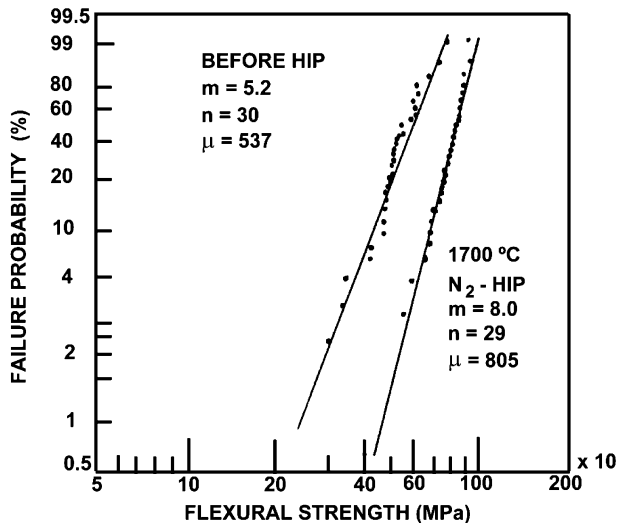

Figure 28 Weibull plot flexural strength for SSN-1 [From ref. 9].

to improve the strength by N_2 -HIP. Now, the properties of Si_3N_4 prior to and after HIPing are summarized in Table V.

Fig. 28 shows the results of the Weibull plot of the bending test for SSN-1 (see Table IV) before and after N_2 gas HIPing. The average flexural strength was enhanced from 573 to 805 MPa and the Weibull modulus from 5.2 to 8.0. The results of this study imply that HIPing of sintered silicon nitride, especially using N_2 gas, is very much promising method to improve strength and scatter [3, 19, 22]. When we think of the future production of parts with complicated shapes and reasonable strength and reliability, such a gas turbine rotors [70, 75] this method seems to be must likely choice for commercial utilization.

The microstructural change during HIP processing would affect the mechanical properties and would in some cases improve the structure and another cases degrade the structure. From Table V, it can be conjectured that the less the β content before HIP processing [19], the more improvement of the flexural

TABLE V Properties Si₃N₄ prior to and after HIP treatment

Sample	Prior to HIP			Kinds of gas for HIP	After HIP (1700°C)		
	Density (g·cm ⁻³)	β-Si ₃ N ₄ (%)	F.S. ^a (MPa)		Density (g·cm ⁻³)	β-Si ₃ N ₄ (%)	F.S. ^a (MPa)
HPSN-1	3.04	97	690	Ar	3.07	100	560
SSN-1	3.15	57	500	N ₂	3.16	100	740
				Ar	3.20	75	590
SSN-2	3.21	100	580	N ₂	3.23	75	820
				Ar	3.24	100	520
RBSN-1	2.94	100	430	N ₂	3.29	100	550
				Ar	3.03	100	360
				N ₂	3.03	100	400

^aF.S.: Flexural strength [From ref. 22].

TABLE VI Properties of dense β-Si₃N₄ without additives fabricated by HIPing [From ref. 76]

Property	RT	1200°C
Theoretical density (g·cm ⁻³)	3.192	
Bulk density (g·cm ⁻³)	3.170	
Vickers microhardness (GPa)	21	12.5
Fracture toughness (MNm ^{-3/2})	3.0–4.0	2.3
Flexural strength (MPa)	400–500	400
Young's modulus (GPa)	308	300
Thermal conductivity (W·mk ⁻¹)	26	20
Thermal expansion coefficient (K ⁻¹)		3.0 × 10 ⁻⁶

strength can be expected according to the Fig. 27 and Table V. This suggests that the densification should proceed associated with a α-β phase transformation. Besides this, the Table VI shows the mean values of physical, mechanical and thermal properties of dense β silicon nitride without additive and fabricated by means of HIPing [76].

Concerning the hardness of Si₃N₄, this was measured under high temperature conditions. Hardness vs. test temperature is illustrated in Fig. 29 for samples obtained with powder B and C (>90 and >95% α-phase respectively). Hardness is logarithmically plotted against the inverse of temperature. It appears with

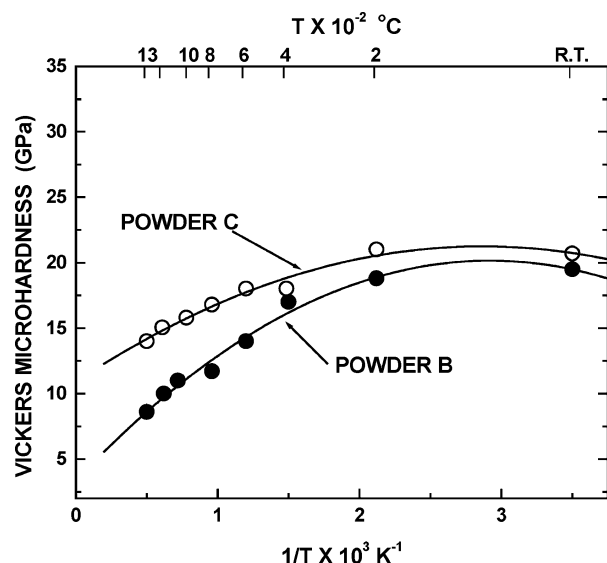

Figure 29 Temperature dependence of Vickers microhardness (HIP: 2000°C; 150 MPa, 2 h) [From ref. 32].

TABLE VII Effect of HIP treatment on mechanical properties of silicon nitride [From ref. 8]

Properties	Nitruro de Silicio	
	Before HIP	After HIP
Relative density (%)	95.7	99.7
Hardness (HRA)	92.5	93.5
Bending strength (MPa)	980	1176
Fracture toughness (MPa√m)	7.0	7.5

both groups of samples that hardness decreases along a flat curve within the range of room temperature to 600°C, while the decrement becomes enhanced in the range beyond 800°C is evidently induced by the softening of the grain boundary glassy phase. It is important to point out that the hardness experiments incorporated Schwab's method [32].

The incorporation of ceramic components into conventional internal combustion and advanced turbine engines has been an active research and development goal at GTE Laboratories since 1980. For these applications, GTE has worked exclusively with silicon nitride materials. One particular silicon nitride alloy PY6 (Si₃N₄+6 w/o Y₂O₃) has been utilized for the most demanding applications [77]. The goal of GTE was to identify the upper limit of fracture toughness for monolithic PY6 silicon nitride and develop processing techniques to obtain these values in AGT-5 (Allison Gas Turbine Division of General Motors) rotor material densified by Hot Isostatic Pressing (HIP).

A variety of exploratory HIP experiments has been performed to help understand the effects of HIP temperature, pressure, and soak time on the microstructural development of ceramics materials. Despite not significantly increasing the fracture toughness of the silicon nitride ceramics, the information generated is very useful in developing a paradigm for selecting appropriate HIP conditions for a given material. Table VII shows the change in mechanical properties of silicon nitride (Si₃N₄) by HIP.

5.2. Silicon carbide (SiC)

SiC is another material which typically cannot fully sintered by conventional processes without such additives as boron, carbon, or their compounds. Like Si₃N₄, SiC

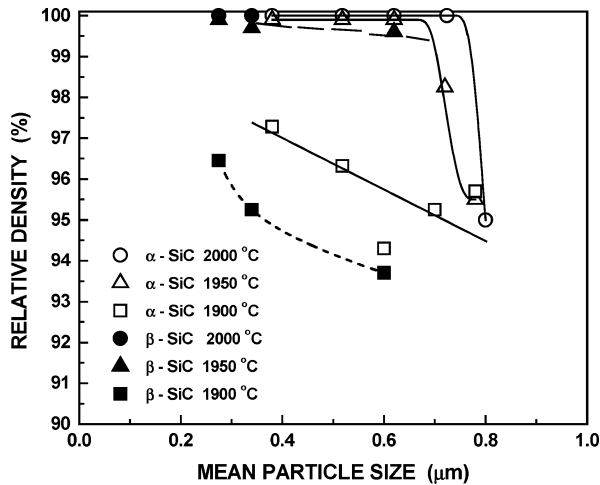

Figure 30 Relationship between mean particle size and relative density of the HIP treated compacts [From ref. 1].

is a family of materials each with its special characteristics. SiC [70, 78], actually increases in strength with temperature, starting slightly above 60,000 psi flexural strength at room temperature and increasing to around 80,000 psi at 1600°C. Relatively pure silicon carbide also has excellent resistance to corrosion in the hot acids and bases. At the present time, various SiC powders have been successfully densified without additives utilizing the encapsulation method as stated in the previous section. Silicon carbide has attracted attention for its high temperature structural application, especially those above 1200°C. As well that of silicon nitride [1, 24], HIP application to silicon carbide has been studied. For example, Fig. 30 shows one of the results obtained with this material. In this figure, the relationship between the mean particle size of the starting powders and the relative density of the HIP treated compact is shown. As can be observed in the figure, almost 100% densification was achieved in fine powders with mean particle size smaller than 0.6 μm and HIP temperatures higher than 1950°C. The difference in sinterability between α-SiC and β-SiC cannot be seen above 1950°C, but below 1900°C α-SiC is densified more easily than β-SiC.

The dispersion processing of SiC whiskers and particles, and the mechanical properties of SiC particle/and/or whisker-reinforced Al₂O₃ composites using HIP technology, has been studied [79]. SiC whiskers and particles were dispersed homogeneously in an Al₂O₃ matrix and the flexural strength and fracture toughness of the hot pressed SiCw-Al₂O₃ composite were up to 836 MPa and 8.1 MPa√m, respectively. Now, the hot pressed composites were further N₂-HIP post-treated and the flexural strength of this post-treated composite was improved by about 37–46%, attaining a value of 1030 MPa. It is very important to see the strengthening resulting from the N₂-HIP post-treatment in order to achieve important properties to structural applications [70, 79, 80].

5.3. Aluminum oxide (Al₂O₃) and Y-PSZ

Oxides are older ceramic materials than nitrides or carbides, and therefore, the application of HIP process has

already been used for commercial production and will be examined later on. Moreover, it is the same composition as sapphire, which accounts for its high hardness and durability. Al₂O₃ ceramic is produced by compacting alumina powder into a shape and firing the powder at high temperature to allow it to densify into a solid, polycrystalline, nonporous parts [70]. Present research and development activity is focussed on the application of O₂-HIPing, namely, HIPing using and Argon-Oxygen gas mixture as pressure medium. Alumina cutting tool inserts-Al₂O₃ and Al₂O₃-TiC cutting tool inserts are widely used in the machining of cast iron parts, such as cylinder blocks for reciprocal engines. Likewise, HIPed alumina inserts exhibit longer life than normally sintered ones and can be manufactures at a reasonable cost [20, 24, 58].

Through the experience gained from HIPing of these oxide ceramics, it was recognized that the HIPing atmosphere affects the color and other mechanical or electrical properties [81]. Recently HIPing using and argon-oxide mixture gas as pressure medium, has been attracting attention as it avoids undesirable property changes and keeps the natural color of the oxide ceramic.

Several early studies proved that oxide ceramics HIPed in an oxidizing atmosphere scarcely change in quality and that their properties are superior to those HIPed in an inert atmosphere [15]. It is well known that Al₂O₃ ceramics has been used as structural materials since they exhibit superior mechanical properties when appropriately fabricated. In spite of this, the mean bending strength of commercially used Al₂O₃ ceramics is of about 300 MPa, whereby the applications of these ceramics are still limited. Al₂O₃ ceramics would be widely used for engineering applications if their bending strength is improved to the level exhibited from Si₃N₄ or SiC, which are currently used as high performance ceramics for engineering applications because of their high bending strength, which is about of 800 MPa. Thus, in order to use Al₂O₃ ceramics for ball-bearing systems, for example, an enhancement of their bending strength to the level of at least 1 GPa is required [82].

It is known that Al₂O₃-ZrO₂ composites attain high mechanical properties because of the enhanced toughening effect, mainly developed through the stress induced phase transformation mechanism, upon ZrO₂ particles addition [83, 84]. Both normal sintering and capsule-free HIP sintering have been performed in these composites in order to study the flexural strength behavior, since undoubtedly the ZrO₂ contents influences the strength of the composites. Although 1.0 wt% of ZrO₂ cannot enhance the strength sufficiently, a mean strength of 757 MPa was achieved by adding 5.0 wt% of ZrO₂ via normal sintering at 1873 K. On the other hand, HIP sintering enhances the average strength of composites containing 5.0 wt% ZrO₂ to 958 MPa at 1723 K. However, the strengthening effect observed in adding 5.0 and 10.0 wt% ZrO₂ is similar, so that 5.0 wt% of ZrO₂ is enough to improve the properties of the composites by means of HIP technology [82–85].

TABLE VIII Results of density measurements for the samples before and after the aging test as well as before HIPing [From ref. 15]. Reprinted from Y. Manabe, T. Fujikawa and Y. Narukawa, "Effect of O₂-HIP for Oxide Ceramics," 2nd International Conference on Hot Isostatic Pressing—Theory and Applications, Maryland, USA, June 1989, with permission of ASM International

Heater element Press. Med. Gas	Before HIP	Graphite argon	Molyb. argon	Pt-Rh Ar + 20%O ₂	Pt-Rh Ar + 10%O ₂	Pt-Rh Ar + 1%O ₂
Alumina						
Before aging	3.903	3.971	3.984	3.975	3.977	3.978
After aging	3.907	3.977	3.978	3.978	3.976	—
Y-PSZ						
Before aging	6.085	6.090	6.104	6.100	6.103	6.105
After aging	6.086	6.091	6.089	6.083	6.086	—

With the purpose to obtain an optimization of the sinter-HIP process in Al₂O₃ ceramics, in recent work, a sinter hot isostatic pressing (HIP) model is introduced for Al₂O₃ ceramics, in which the final densification simultaneously includes defining the density development, grain growth and defect size reduction. With this computer model, for the selected combinations of processing and microstructural parameters, the individually dominating mechanisms and the achievable microstructural conditions can thus be identified. This allows the determination of optimal processing at given appropriate conditions, which thus allow the sintering and HIP processes to be optimally planned [86].

Equally, it has been shown that Y-PSZ materials HIPed in argon atmosphere degraded considerably in strength and that Y-PSZ materials HIPed in an oxidizing atmosphere degraded only minimally, when aged in air at 1000°C for 1000 h [87]. It is thought that the cause of this degradation is the reducing reaction during the HIP process as well as the invasion of carbon because a graphite heater used when HIPing is an argon atmosphere.

The results of density measurements for the samples before and after the aging test as well as before HIPing, are shown in Table VIII. The Y-PSZ sample as HIPed using graphite heater was black, the other Y-PSZ samples exhibited a yellowish white color. The color of the black Y-PSZ sample changed to yellowish white color after de aging test in air. Now, for alumina, the color changes were more complicated. The color before HIPing was pinkish. After HIPing in an argon-oxygen gas mixture, it turned bright orange with a little translucence. Samples HIPed in pure argon with the molybdenum heater changed from a slightly translucent white just after HIPing to orange after the aging test.

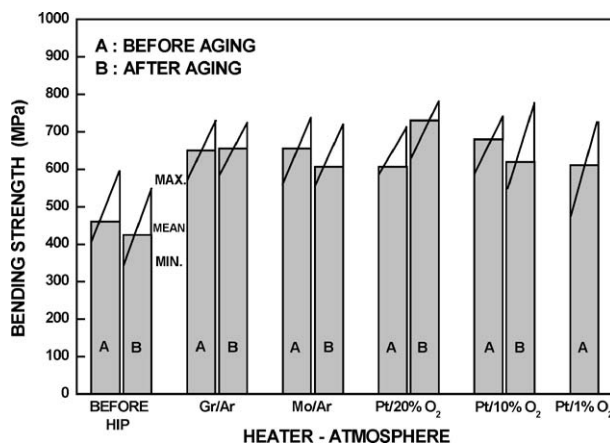

Figure 31 Results of the measurement of 3-point bending strength for alumina [From ref. 15]. Reprinted from Y. Manabe, T. Fujikawa and Y. Narukawa, "Effect of O₂-HIP for Oxide Ceramics," 2nd International Conference on Hot Isostatic Pressing—Theory and Applications, Maryland, USA, June 1989, with permission of ASM International.

Fig. 31 gives the bending strength for alumina. The average bending strength was improved by HIPing from about 470 MPa to near 690 MPa. There was little difference in strength whether and oxidizing atmosphere or argon one was used, and there was little difference before or after aging. The average bending strength of Y-PSZ was enhanced from 1000 MPa to about 1500 MPa or higher by HIPing [15].

The Table IX shows the results of the Vickers microhardness test. Compared with the results for Y-PSZ, the hardness of the sample HIPed using the graphite heater degrades by aging more than any other sample. For alumina, the hardness of the sample HIPed using graphite heater increases with aging test. One important benefit of Hot Isostatic Pressing is a reduction in size and number of pores. Since ceramic tool materials are

TABLE IX Results of the Vickers microhardness for alumina and Y-PSZ [From ref. 15]. Reprinted from Y. Manabe, T. Fujikawa and Y. Narukawa, "Effect of O₂-HIP for Oxide Ceramics," 2nd International Conference on Hot Isostatic Pressing—Theory and Applications, Maryland, USA, June 1989, with permission of ASM International

Heating element Press. Med. Gas	Before HIP	Graphite argon	Molybdenum argon	Pt-Rh Ar + 20%O ₂	Pt-Rh Ar + 10%O ₂
Alumina					
Before aging	1.744	1.906	1.964	1.928	1.932
After aging	1.729	1.974	1.941	1.911	1.985
Y-PSZ					
Before aging	1.284	1.295	1.290	1.292	1.300
After aging	1.264	1.259	1.279	1.280	1.271

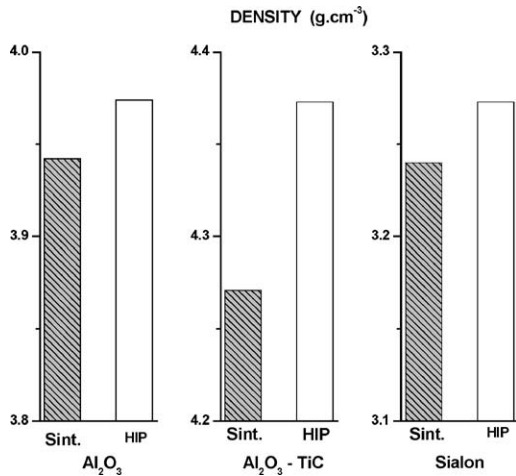

Figure 32 Increase in densities of Al₂O₃, Al₂O₃-TiC and sialon ceramics due to Hot Isostatic Pressing [From ref. 88].

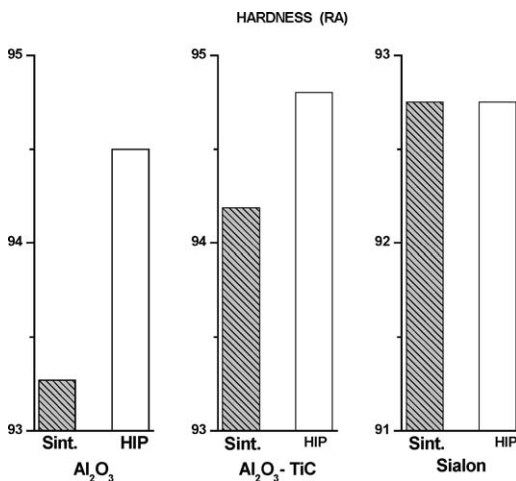

Figure 33 Effect of Hot Isostatic Pressing on hardness of Al₂O₃, Al₂O₃-TiC and sialon ceramics [From ref. 88].

relatively difficult to densify by pressureless sintering, a subsequent step of Hot Isostatic Pressing is useful in reducing the final porosity.

The reduction in porosity of ceramic tool materials by HIP results in a higher density. Fig. 32 illustrates this trend for Al₂O₃, Al₂O₃-TiC and sialon ceramics. This figure shows that the Al₂O₃-TiC composition is benefited more by HIP than Al₂O₃, since the former is relatively more difficult to densify by pressureless sintering. Fig. 33 illustrates the change in hardness of Al₂O₃, Al₂O₃-TiC and sialon due to HIP. While both Al₂O₃, Al₂O₃-TiC experienced increases in hardness, the hardness of sialon was essentially unchanged.

Now, fracture is an undesirable mode of metalcutting tool failure due to its unpredictable nature [88], which results in inconsistent tool-lives. Furthermore, catastrophic fractures can result in damage to the machine tool and ruining of expensive workpiece. Then, this tendency to fracture of ceramic cutting tool materials may be significantly reduced by HIP process.

Fig. 34, depicts tool lives of a sialon cutting tool material in milling cast iron. Although the average tool-life remain more or less unchanged, Hot Isostatic Pressing may significantly reduce the scatter in tool-lives. This improvement is owing to a change in tool failure mode

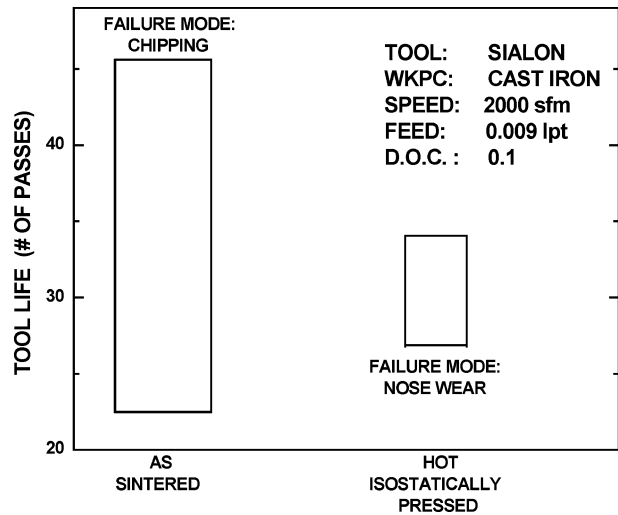

Figure 34 Reduction in the scatter of tool-lives of a sialon cutting tool material in milling cast iron. Tool failure due to nose wear is preferred over chipping [From ref. 88].

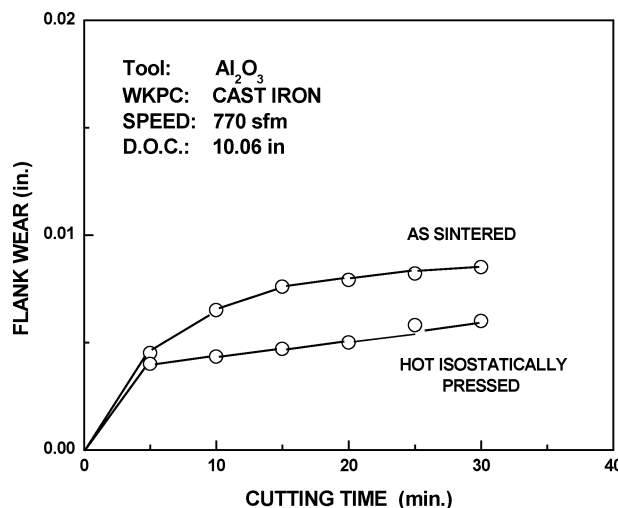

Figure 35 Effect of Hot Isostatic Pressing in reducing flank wear on an Al₂O₃ cutting tool material milling cast iron [From ref. 88].

from chipping or fracture for the as-sintered material, to wear which is a more predictable tool failure mode for the HIPed inserts. HIP may also result in a reduced wear rate for the cutting tool materials. For example, Fig. 35 illustrates the progression of flank wear in an Al₂O₃ cutting tool with the time. The Hot Isostatic Pressed material exhibits a lower wear rate than the sintered version of the same material.

It is important to stress that coatings are another important ceramics option [70]. In this case, a thin surface layer of ceramic deposited on metal or ceramic imparts favorable ceramic characteristics such as corrosion resistance or wear resistance while retaining the durability and structural benefits of the substrate. Thermal barrier coatings of ZrO₂ are currently in production to protect metals in the hot sections of military and commercial aircraft gas turbine engines. Recent work [89], shows the modifications made in the pore size distribution of yttria stabilized zirconia (YSZ) composite coatings by means of Hot Isostatic Pressing. The YSZ coatings which were HIPed for 1 and 3 h in the temperature range 1000 to 1200°C and about 185 MPa showed

a small decrease in the average porosity (approximately 2.5%) for the 1 h samples. On the other hand, the hardness increased about 39%, and there was a corresponding increase in the coating density, due to reduction of the average pore size in the HIPed coatings.

5.4. Cemented carbide and others

Cemented carbide and fine ceramics are inferior to metals such as steel and aluminum in toughness and very vulnerable to defects such as coarse particle and pore. It is necessary to remove such internal defects in order to make full use of the natural characteristics of these materials, and HIP is the most effective means to eliminate those defects.

Since a liquid phase of metal such as cobalt is utilized as a binder phase in the sintering of cemented carbide, it is possible to compact a normal sintered body nearly up to the theoretical density. However there remain fine pores in the sintered body and they act fatally to the cemented carbide to break under a pressure that can be withstood in normal condition. It is the purpose of HIP treatment to eliminate completely a few pores existing in the sintered body [8]. Table X shows the change in mechanical properties by HIP of cemented carbide.

As shown above, the density and hardness of cemented carbide are not changed by HIP treatment. However, by the removal of fine pores, the bending strength is largely improved and the dispersion in strength becomes very small to increase reliability as shown in Fig. 36.

Concerning to HIP treatment for castings, the Table XI shows the effect of the HIP treatment against Ni-based super alloy and Ti alloys casting. The effect

TABLE X Effect of HIP treatment on mechanical properties of cemented carbide [From ref. 8]

Properties	Cemented carbide	
	Before HIP	After HIP
Relative density (%)	Nearly 100	Nearly 100
Hardness (HRA)	91.0	91.0
Bending strength (MPa)	2450	2940
Fracture toughness (MPa \sqrt{m})	10.0	10.5

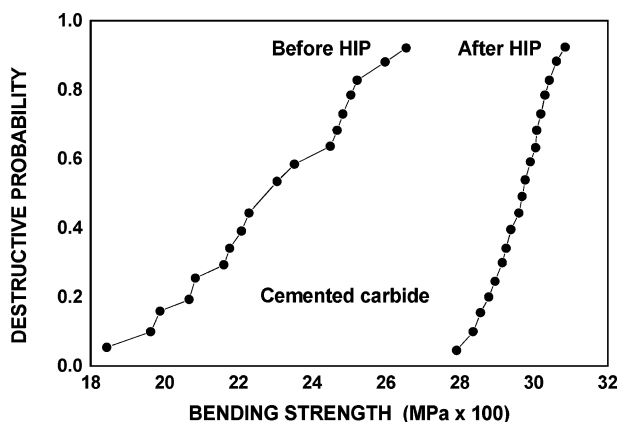

Figure 36 Weibull plot of bending strength before and after HIP treatment of cemented carbide [From ref. 8].

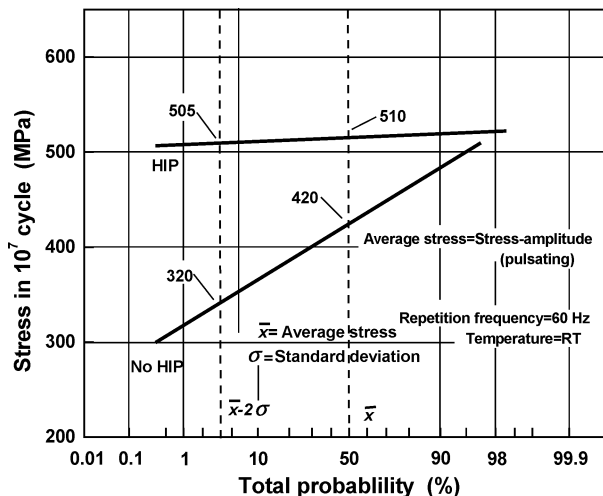

Figure 37 Influence of HIP on high-cycle fatigue strength of Ti-6Al-4V casting [From ref. 7].

depends on the type of alloy, however, the duration is improved 1.3–3.5 times and its elongation and aperture are also improved. Fig. 37 shows the influence of HIP on high-cycle fatigue strength of Ti-6Al-4V casting. The average stress of fatigue fracture at 10^7 cycle is 420 MPa for the castings themselves, however, it improved up to 510 MPa for castings that had been treated with the HIP method. One remarkable point is that of a 2σ value for castings is 320 MPa, on the other hand, it is over 500 MPa for the HIP treatment.

As mentioned above, the fatigue fracture line of the HIP treatment is almost parallel with horizontal axis, which indicates that the reliance of Ti-6Al-4V castings are improved extensively by the HIP treatment [7].

6. Size of the HIP device

The size of the HIP device is usually described to the inside diameter of a furnace and the height inside the furnace is around 3–4 times that of the diameter inside the furnace. The device being below 200 mm of the size of the inside diameter is generally used for research and development, and that having 200 mm or above of the inside diameter is generally for production use.

Domestically HIP is developed in the fields of sintered hard alloys and ceramics, however, the majority of these fields produce sophisticated small shape products and demands for large devices are few. Meanwhile, in Europe and US, HIP is mainly used for eliminating casting defects for aircraft parts and the large devices having 1000 mm or above of the inside diameter are installed a lot. The largest HIP device in the world, which is installed in the US, is the metal process device having 1625 mm of the inside diameter of a furnace and 2540 mm of high [7].

All the products developed by HIP are high value added and difficult to manufacture with other methods. Engine turbine discs, materials for the construction of aircraft parts, rolls for metal rolling, cylinders for injection molding, soft ferrites, Al_2O_3 cutware, jet engine turbine blade, etc., are parts that can be developed by Hot Isostatic Pressing (HIP).

TABLE XI Creep rupture characteristics of Ni-base super alloys [From ref. 7]

Alloys	Conditions	Test conditions		Life ($\times 10^3$ s)	Elongation (%)	Reduction area (%)
		Temperature (K)	Stress (MPa)			
IN738	Casting	1.253	152	68.4	11.8	20.0
	Casting + HIP	1.253	152	189.0	20.5	20.6
Rene77	Casting	1.253	152	183.6	19.4	37.0
	Casting + HIP	1.253	152	244.8	22.0	55.0
IN792	Casting	1.143	310	630.0	9.2	6.5
	Casting + HIP	1.143	310	1,018.8	12.1	22.0
Rene80	Casting	1.143	310	149.4	2.5	2.5
	Casting + HIP	1.143	310	507.6	11.5	17.0

References

- S. KOFUNE, C. MANABE, T. FUJIKAWA, T. KANDA, F. YAMAMOTO and H. OKAWA, in Proceedings of the 3rd International Conference on Hot Isostatic Pressing, London, UK, 10–12 Nov. 1986, edited by MPR Publishing Services Ltd. (1986) Vol. 1, p. 1.
- G. ZIEGLER, J. HEINRICH and G. WOTTING, *J. Mater. Sci.* **22** (1987) 3041.
- W. BRIAN JAMES, *Mater. Design* **8** (1987) 187.
- F. X. ZIMMERMAN, *Ceram. Ind.* **148** (1998) 33.
- S. MUSSMAN, *Mater. World* **7** (1999) 677.
- <http://www.aiphp.com>, American Isostatic Presses, Inc. Technical Literature, Columbus, Ohio, 2002.
- <http://www.kobelco.co.jp>, Kobe Steel, Ltd., Advanced Products & Technologies Dept. Machinery Company, Technical Literature, 2001.
- <http://www.nittan.co.jp>, Nippon Tungsten Co., Ltd., Technical Literature, 2002.
- T. FUJIKAWA, M. MORITOKI and K. HOMMA, in Papers Presented 2nd International Conference on Hot Isostatic Pressing, Stratford-upon-Avon, 21–23 Sept. 1982 (MPR Publishing, Shrewsbury, 1982) Vol. 1.
- <http://www.vdww.com>, Valenite Die & Wear/Walmet, Technical Literature, 2001.
- M. J. HOFFMANN, A. GEYER and R. OBERACKER, *J. Eur. Ceram. Soc.* **19** (1999) 2359.
- P. ARATO and F. WEBER, *Key Eng. Mater.* **161–163** (1998) 221.
- Y. SHINODA, T. NAGANO and F. WAKAI, *J. Amer. Ceram. Soc.* **82** (1999) 771.
- S. DONG, D. JIANG, S. TAN and J. GUO, *J. Mater. Sci. Lett.* **16** (1997) 1080.
- Y. MANABE, T. FUJIKAWA and Y. NARUKAMA, in Second International Conference on Hot Isostatic Pressing—Theory and Applications (7–9 June 1989), National Institute of Standards and Technology, Gaithersburg, Maryland USA (ASM International, Materials Park, OH, USA, 1991) p. 1.
- A. G. SOLOMAH, *Ceram. Eng. Sci. Proc.* **18** (1997) 219.
- M. YOSHINADA, K. HIROTA, M. ITO, H. AKANO and O. YAMAGUCHI, *J. Amer. Ceram. Soc.* **82** (1999) 216.
- M. MORITOKI, in Conference of Hot Isostatic Pressing: A Global Assessment, Danvers, March 30–April 1, 1982.
- T. FUJIKAWA, M. MORITOKI, T. KANDA, K. HOMMA and H. OKADA, in Proceedings of International Symposium on Ceramic Components for Engine, Japan, edited by Shiyeyuki Somiya, Eigo Kanai and Kenishiro Ando (KTK Scientific Publ. Tokyo, 1983) p. 425.
- S. M. BARINOV, V. F. PONOMAREV and V. CHEVCHENKO, *Refract. Ind. Ceram.* **38** (1997) 9.
- H. T. LARKER and R. LUNDBERG, *J. Eur. Ceram. Soc.* **19** (1999) 2367.
- K. HOMMA, T. TATSUNO, H. OKADA and T. FUJIKAWA, in Proceedings of the Twentyfifth Japan Congress on Materials Research (Society of Materials Science, Kyoto, Japan, 1982) p. 213.
- S. YIN, S. UCHIDA, Y. FUJISHIRO, M. OHMORI and T. SATO, *Br. Ceram. Trans.* **98** (1999) 1923.
- T. FUJIKAWA and N. KAWAI, in 2nd International Conference on Hot Isostatic Pressing—Theory and Applications, National Institute of Standards and Technology, Gaithersburg, Maryland, USA 7–9 June 1989 (ASM International, Materials Park, OH, USA, 1991) p. 87.
- A. ZULFIA, H. V. ATKINSON, H. JONES and S. KING, *J. Mater. Sci.* **34** (1999) 4305.
- K. A. KHOR and Y. W. GU, *Mater. Lett.* **34** (1998) 263.
- R. CHAIM and M. HEFETZ, *J. Mater. Res.* **13** (1998) 1875.
- M. MIODOWNIK and B. DERBY, *J. Amer. Ceram. Soc.* **82** (1999) 3616.
- J.-F. YANG, Y.-H. CHOA, J. P. SINGH and K. NIIHARA, *J. Ceram. Soc. Jap.* **106** (1998) 951.
- M. AGARWALA, D. KLOSTERMAN, N. OSBORNE and A. LIGHTMAN, in Solid Freeform Fabrication Symposium, Austin, TX, August, 1999.
- H. V. ATKINSON and B. A. RICKINSON, in Hot Isostatic Pressing, The Adam Hilger Series on New Manufacturing Processes and Materials, edited by John Wood (Nottingham University, 1991) Chap. 1, p. 1.
- T. FUJIKAWA, Y. INOUE, K. HOMMA, T. TATSUNO, H. OKADA and N. KONDO, *Kobelco Techn. Rev.* **3** (1988) 1.
- W. R. MORGAN and R. L. SANDS, *Metall. Rev.* **14** (1969) 85.
- T. ISHII, in Proceedings of International Symposium on Ceramic Components for Engine, Japan, edited by Shiyeyuki Somiya, Eigo Kanai and Kenishiro Ando (KTK Scientific Publ., Tokyo, 1983) p. 425.
- H. V. ATKINSON and B. A. RICKINSON, in Hot Isostatic Pressing, The Adam Hilger Series on New Manufacturing Processes and Materials, edited by John Wood (Nottingham University, 1991) Chap. 3, p. 53.
- H. D. B. RAES, *Powder Met.* **26** (1983) 193.
- C. E. MUZZALL, *Metall. Rev.* **14** (1969) 85.
- E. S. HODGE, C. B. BOYER and F. D. ORCUTT, *Indust. Eng. Chem.* **54** (1962) 31.
- R. L. SANDS, E. P. HERBERT and W. R. MORGAN, *Powder Met.* **8** (1965) 129.
- E. S. HODGE, *Metall. Rev.* **14** (1969) 85.
- S. KOFUNE, C. MANABE and T. FUJIKAWA, in Proceedings of the 3rd International Conference on Hot Isostatic Pressing, London, UK, 10–12 Nov. 1986, edited by MPR Publishing Services Ltd. (1986) Vol. 1, p. 71.
- S. H. LEE, *J. Korean Ceram. Soc.* **35** (1998) 659.
- Z. HUANG, D. JIANG and S. TAN, *J. Chin. Ceram. Soc.* **25** (1997) 30.
- K. WATARI, K. HIRAO, M. E. BRITO, M. TORIYAMA and S. KANZAKI, *J. Mater. Res.* **14** (1999) 1538.
- J. HEINRICH and M. BOHMER, *Sci. Ceram.* **11** (1981) 439.
- K. HOMA, H. OKADA, T. FUJIKAWA and T. TATSUNO, *Yogyo Kyokai Shi* **95** (1987) 91.
- M. SHIMADA and H. ISHITOBI, in 2nd International Conference on Hot Isostatic Pressing, Stratford-upon-Avon, Sept. 21–23 (1982).
- J. C. UY and E. R. HERMANN, 2nd International Conference on Hot Isostatic Pressing, Stratford-upon-Avon, Sept. 21–23 (1982).

49. H. T. LARKER, in "Progress in Nitrogen Ceramics," edited by F. L. Riley (Martins Nijhoff Publishers, The Hague, 1983) p. 720.
50. L. HERMANSONN, T. HOLSTROM and H. T. LARKER, in ISO 3, Conference, London, Nov. 1986.
51. J. ADLERBORN, M. BURSTROM, L. HERMANSONN and H. T. LARKER, *Mater. Design* **8** (1987) 229.
52. D. S. PERERA, M. TOKITA and S. MORICCA, *J. Eur. Ceram. Soc.* **18** (1998) 401.
53. K. NIIHARA, T. SEKINO, E. YASUDA and T. SASA, *Key Eng. Mater.* **161–163** (1998) 221.
54. G. WOTTING and G. ZIEGLER, in "Ceramic Powders," edited by P. Vincenzini (Elsevier, Amsterdam, 1983) p. 951.
55. O. YEHESEKEL, Y. GEFEN and M. TALIANKER, *Mater. Sci. Engng.* **78** (1986) 209.
56. C. GRESKOVICH, *J. Amer. Ceram. Soc.* **64** (1981) 725.
57. I. ITURRIZA, F. CASTRO and M. FUENTES, *J. Mater. Sci.* **24** (1989) 2047.
58. Y. KINEMUCHI, N. FUSAMUNE, A. TAKATA and K. ISHIZAKI, *J. Ceram. Soc. Jap.* **106** (1998) 435.
59. G. YA AKIMOV, V. G. VERESHCHAK, A. D. VASIL'EV, V. M. TIMCHENKO, E. V. CHAIKA and A. D. GRABCHUK, *Refract. Ind. Ceram.* **39** (1998) 324.
60. S. DONG, Z. CHEN, S. TAN, D. JIANG and J. GUO, *J. Chin. Ceram. Soc.* **26** (1998) 754.
61. S. M. BARINOV, V. F. PONOMAREV, V. YA SHEVCHENKO and D. SHAWRAN, *J. Mater. Sci. Lett.* **14** (1995) 871.
62. M. ROSSO, C. MUS and G. CHIARMETTA, *Metal. Sci. Tech.* **18** (2000) 16.
63. E. ROMANO, M. ROSSO and C. MUS, *ibid.* **19** (2001) 21.
64. Hitchiner Manufacturing Co., Inc., Ferrous Division/Gas Turbine Division, Technical Update 3D4, Scientific Literature, 2001.
65. S. GALLO, *Metal. Sci. Tech.* **19** (2001) 1.
66. S. GALLO, C. MUS and G. MORTARI, *ibid.* **19** (2001) 16.
67. H. V. ATKINSON and B. A. RICKINSON, in "Hot Isostatic Pressing, The Adam Hilger Series on New Manufacturing Processes and Materials," edited by John Wood (Nottingham University, 1991) Chap. 7, p. 107.
68. ISOTRON, HIP Bonded Products, Kobe Steel, Ltd., Catalogue, 1990.
69. Kinzoku Giken Co., Ltd., Technical Literature, 2002.
70. D. W. RICHERSON and D. W. FREITAG, in Opportunities for Advanced Ceramics to Meet the Needs of the Industries of the Future, DOE/ORO 2076, Prepared by U.S. Advanced Ceramics Association and Oak Ridge National Laboratory (1998) Chap. 2, p. 1.
71. M. K. FERBER and M. G. JENKINS, *J. Amer. Ceram. Soc.* **75** (1992) 2453.
72. S. HAMPSHIRE and K. H. JACK, in "Special Ceramics 7," Proceedings of the British Ceramic Society, 1980, edited by D. Taylor and P. Popper (British Ceramic Society, Stoke on Trent, 1981) p. 37.
73. H. MANDAL, D. P. THOMPSON and K. H. JACK, *Key Eng. Mater.* **159–160** (1999) 1.
74. F. CASTRO and I. ITURRIZA, *J. Mater. Sci. Lett.* **9** (1990) 600.
75. H. T. LIN, P. F. BECHER, M. K. FERBER and V. PARTHASARATHY, *Key Eng. Mater.* **161–163** (1999) 671.
76. K. NEZUDA, Y. MIYAMOTO and M. KIZUMI, in Proceedings of the International Conference on Hot Isostatic Pressing, Lulea Sweden, 15–17 June 1987 (Centek Publishers, Lulea, 1988) p. 359.
77. D. SORDELET, J. NEIL, M. MAHONEY and A. HECKER, The American Society of Mechanical Engineers, ASME, 91-GT-65, 1991.
78. H. KLEMM, M. HERRMANN and D. C. SCHUBERT, *J. Engng. Gas Turb. Power* **122** (2000) 13.
79. D. L. JIANG and Z. R. HUANG, in Novel Synthesis and Processing of Ceramics, Proc. Int. Symp. Kurume, 26–29 Oct. (1997) p. 379.
80. D. W. RICHERSON, in "Composites Engineering Handbook," edited by P. K. Mallick (Marcel Dekker, Inc., New York, 1997).
81. Y. MANABE, T. FUJIKAWA, M. UEDA and Y. INOUE, in Proceedings of the 1st European Ceramic Society Conference (Ecers'89), Maastricht, Netherland, edited by G. De With, R. A. Terpstra and R. Metselaar, June 18–23 (1989).
82. Y. NISHIKAWA, H. KUME, S. DÍAZ DE LA TORRE, S. INAMURA, H. MIYAMOTO, T. KATO and T. MAEDA, in Proceedings of 16th Inte. Japan-Korea Seminar on Ceramics, Nov. 30–Dec. 2, Okayama, Japan (1999).
83. N. CLAUSSEN, *J. Amer. Ceram. Soc.* **59** (1976) 49.
84. P. F. BECHER, *ibid.* **64** (1981) 37.
85. H. KUME, Y. NISHIKAWA, S. INAMURA, H. MIYAMOTO, K. YAMABE and T. MAEDA, *Key Eng. Mater.* **161–163** (1998).
86. S. POEHNITZSCH, G. GRATHWOHL, S. WEISS and R. OBERACKER, *Ceram. Forum Int./Ver. DKG* **76** (1999) 19.
87. T. MASAKI, N. NAKAJIMA and K. SHINDO, *J. Mater. Sci. Lett.* **5** (1986) 1115.
88. K. PANKAJ, *MPR* July/Aug. (1987) 506.
89. K. A. KHOR, *Mater. Manuf. Processes.* **12** (1997) 291.

Received 23 January
and accepted 2 July 2004